



Naqeebe[®]

Enterprises

Catalogue

Manufacturers & Exporters of Surgical, Dental Instruments & Scissors of All Sorts

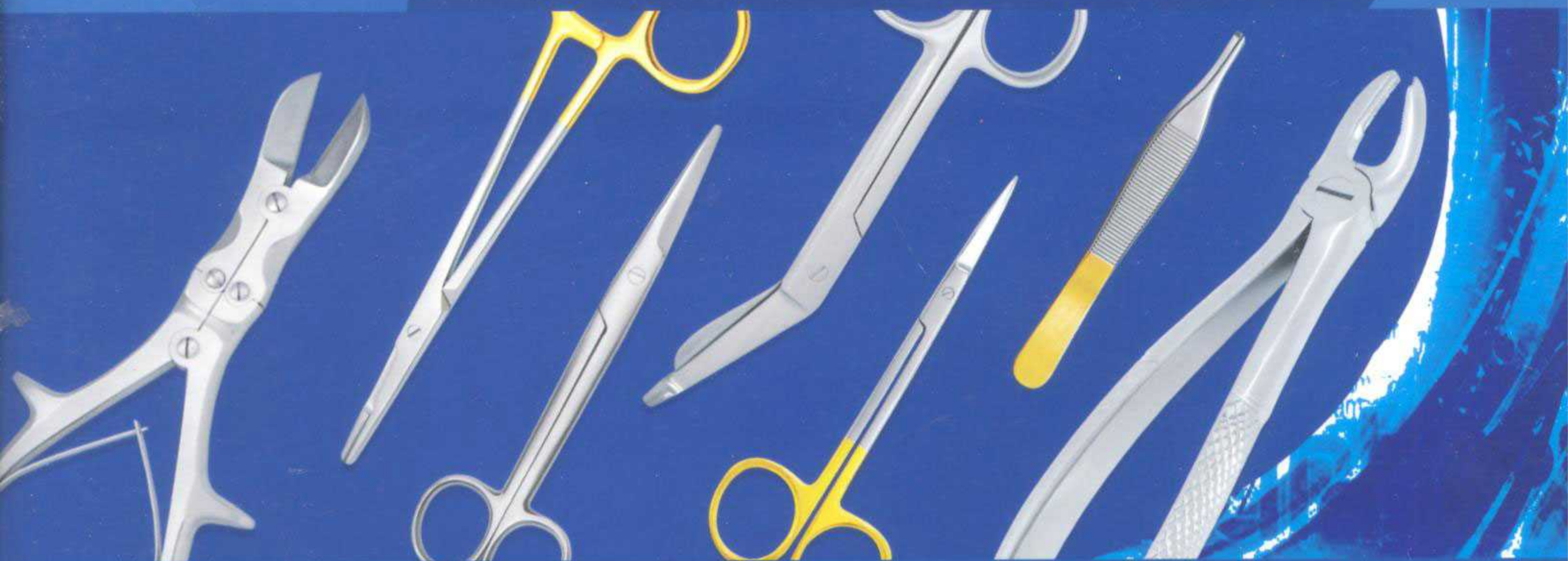

www.naqeebe.com

Naqeebe[®] Enterprises



**Surgical Dental Instruments
Catalogue**



SCISSORS



DEAVER
 NE - 001-05 5½" S/B
 NE - 002-05 5½" S/S
 Straight



DEAVER
 NE - 003-05 5½" S/B
 NE - 004-05 5½" S/S
 Curved



MAYO
 NE - 005-05 5½"
 NE - 006-05 5¾"
 Straight



MAYO
 NE - 007-05 5½"
 NE - 008-06 6¾"
 Curved

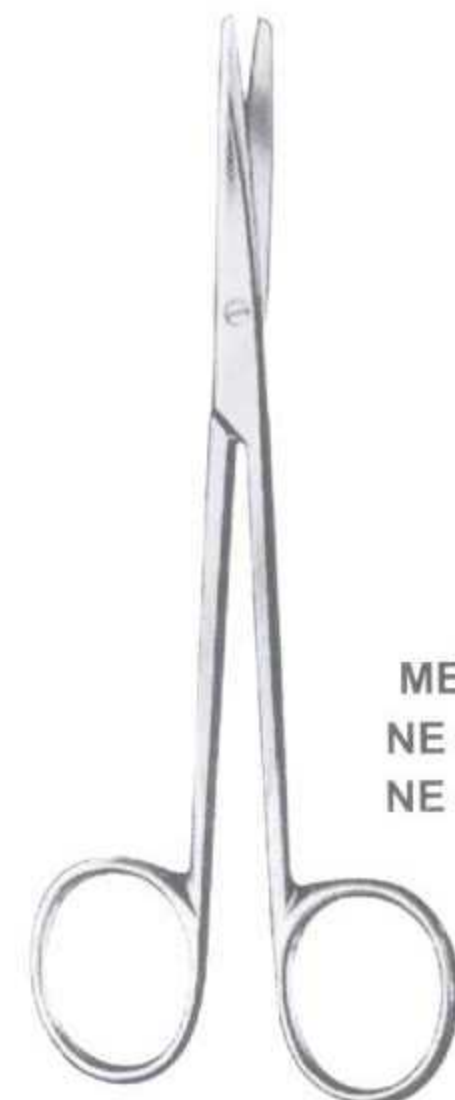

METZENBAUM
 NE - 009-05 5¾"
 NE - 010-07 7"
 Straight



METZENBAUM
 NE - 011-05 5¾"
 NE - 012-07 7"
 Curved



NE - 013-04



NE - 015-04



NE - 015-A



NE - 017-04



IRIS
 NE - 013-04 4½"
 NE - 014-04 4½"
 NE - 015-0A 4½"



STRABISMUS
 NE - 016-04 4½"
 NE - 017-04 4½"

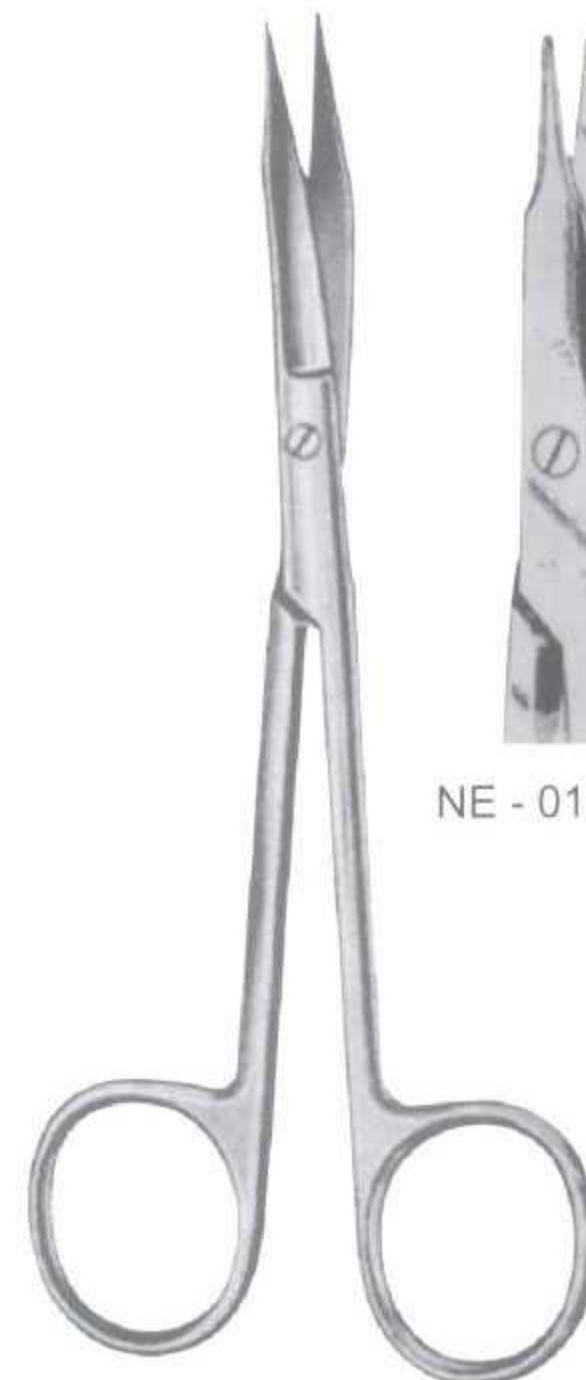

STEVENS TENOTOMY
 NE - 01804 4 ½"
 NE - 019-04 4 ½"



NE - 018-04



NE - 019-04

SCISSORS



KELLY
NE - 020-06 6 1/2"
Smooth



NE - 021-06 6 1/2"
Serrated



KELLY
NE - 022-06 6 1/2"
Smooth



KELLY
NE - 023-06 6 1/2"
Serrated



MAYO NOBLE
NE - 023-06 6 1/2"



MAYO NOBLE
NE - 024-06 6 1/2"



DEAN
NE - 025-07 7 1/4"
Smooth



DEAN
NE - 026-07 7 1/4"
Serrated



BRAUN STADLER
NE - 027-05 5 1/4"
NE - 028-08 8 1/2"



ENTROTOMY
NE - 029-08 8 1/4"



DOYEN
NE - 030-07 7"



NE - 031-07 7"



SIMS
NE - 032-08 8"
NE - 033-09 9"
BL/BL
SH/BL



NE - 034-08 8"



NE - 036-08 8"
NE - 037-09 9"

BL/BL
SH/BL



SCISSORS SHEARS



NE - 039-02 5"

SPENCER
NE - 038-03 3 1/2"
NE - 039-01 5"



LITTAUER
NE - 040-03 4 1/2"
NE - 041-05 5 1/2"



CROWN
NE - 042-04 4 1/2"
NE - 043-0C 4 1/2"



WIRE
NE - 046-04 4 1/2"

PARAMEDIC SHEARS AUTOCLAVABLE



DISSECTING
NE - 047-01 4 1/2"
NE - 047-02 5"



NE - 048-01 4 1/2"
NE - 048-02 5"



UMBILICAL
NE - 049-04 4 1/2"



NE - 050-05 5 1/2"



NE - 051-07 7 1/4"



SCISSORS SHEARS

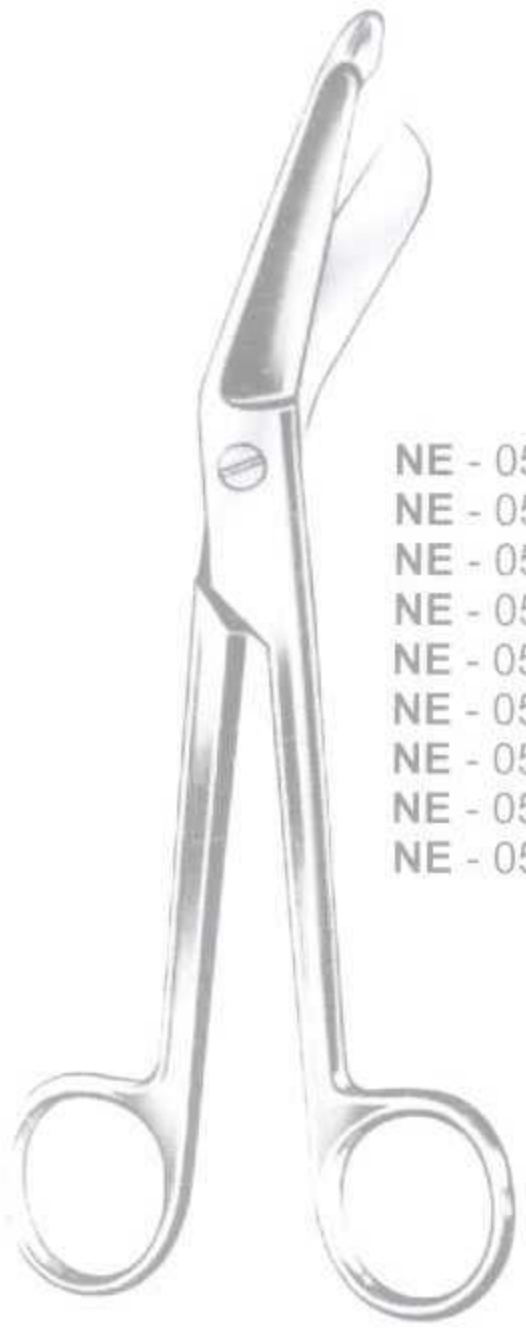

- NE - 052-03 3 1/2"
- NE - 053-04 4 1/2"
- NE - 054-05 5 1/2"
- NE - 055-07 7 1/4"
- NE - 052-01 3 1/2" G.P
- NE - 053-02 4 1/2" G.P
- NE - 054-03 3 1/2" G.P
- NE - 055-04 7 1/4" G.P
- NE - 056-05 5 1/2"

LISTER BANDAGE

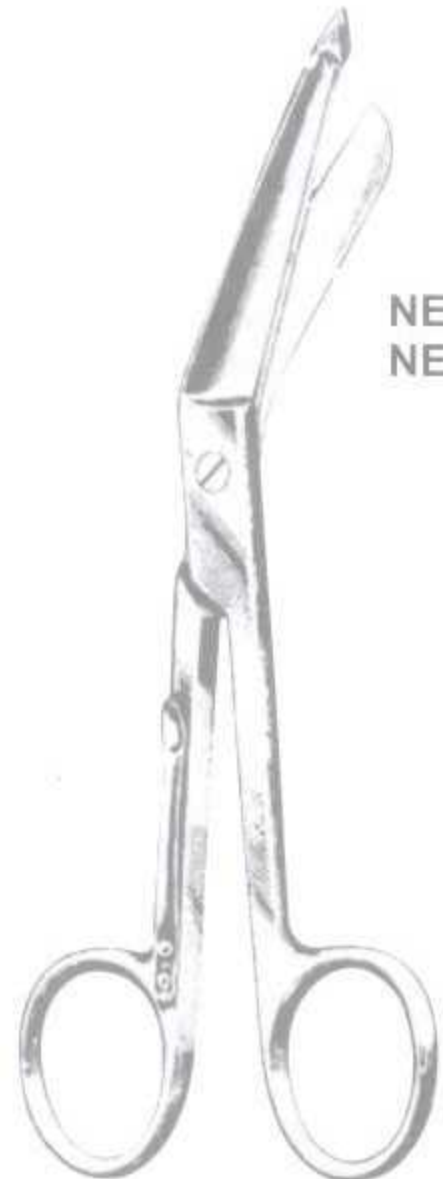

- NE - 057-01 4 1/2"
- NE - 057-02 5 1/2"

**LISTER BANDAGE
(with Clip)**



- NE - 058-01 5 1/2"
- NE - 058-02 7 1/4"
- NE - 058-03 8"

**LISTER BANDAGE
(One Large Ring)**

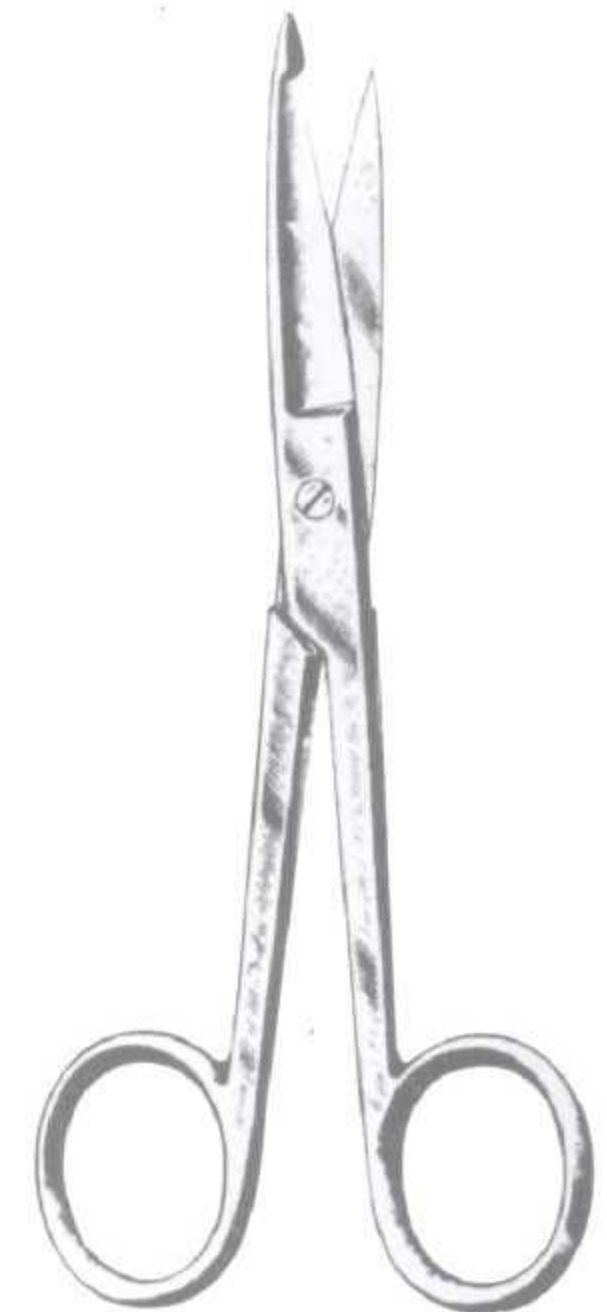

**KNOWLES BANDAGE
NE - 059-05 5 1/2"**



- GAUZE SMITH**
- NE - 060-01 6"
 - NE - 060-02 7"
 - NE - 060-03 8"



- ESMARCH**
- NE - 061-08 8 1/4"



- BRUNS**
- NE - 062-01 8" Serrated
 - NE - 062-02 9" Plain



- FIRST AID**
- NE - 063-08 8"



BONE PLASTER INSTRUMENTS



LISTON
 NE - 064-01 5 1/2"
 NE - 064-02 6 3/4"
 NE - 064-03 7 1/2"
 NE - 064-04 8 3/4"



NE - 064-05 5 1/2"
 NE - 064-06 6 3/4"
 NE - 064-07 7 1/2"
 NE - 064-08 8 3/4"



LUER
 NE - 065-05 6 3/4"
 NE - 065-0C 6 3/4"



Straight



Curved



FINGER RING CUTTERS
 NE - 066-06 6"
 NE - 066-0C C.P.



C.P



WOLFE
 NE - 067-01 7 1/2"
 NE - 067-02 9"
 NE - 067-01 10 1/4"



HENNING
 NE - 068-11 11"



STILLE
 NE - 069-01 10 1/4"
 NE - 069-01 14 1/2"

HEMOSTATICS FORCEPS

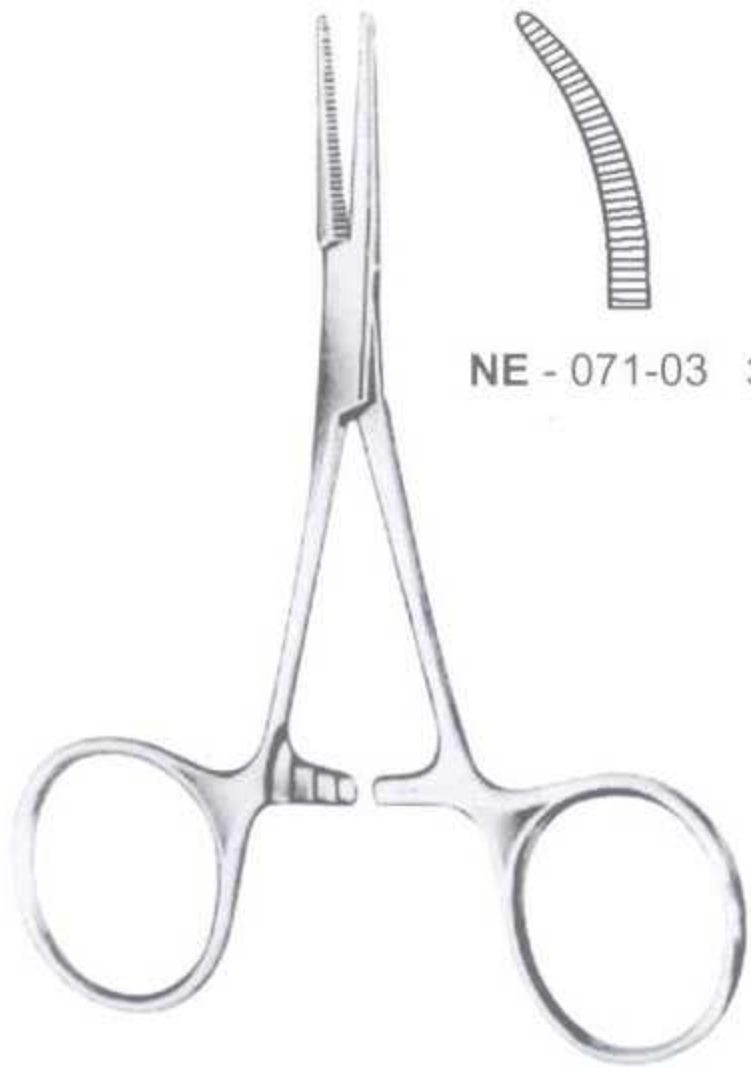

NE - 071-03 3 1/2"

HARTMAN MOSQUITO

NE - 070-03 3 1/2"



MOSQUITO
NE - 072-04 4 1/2"
NE - 073-05 5"

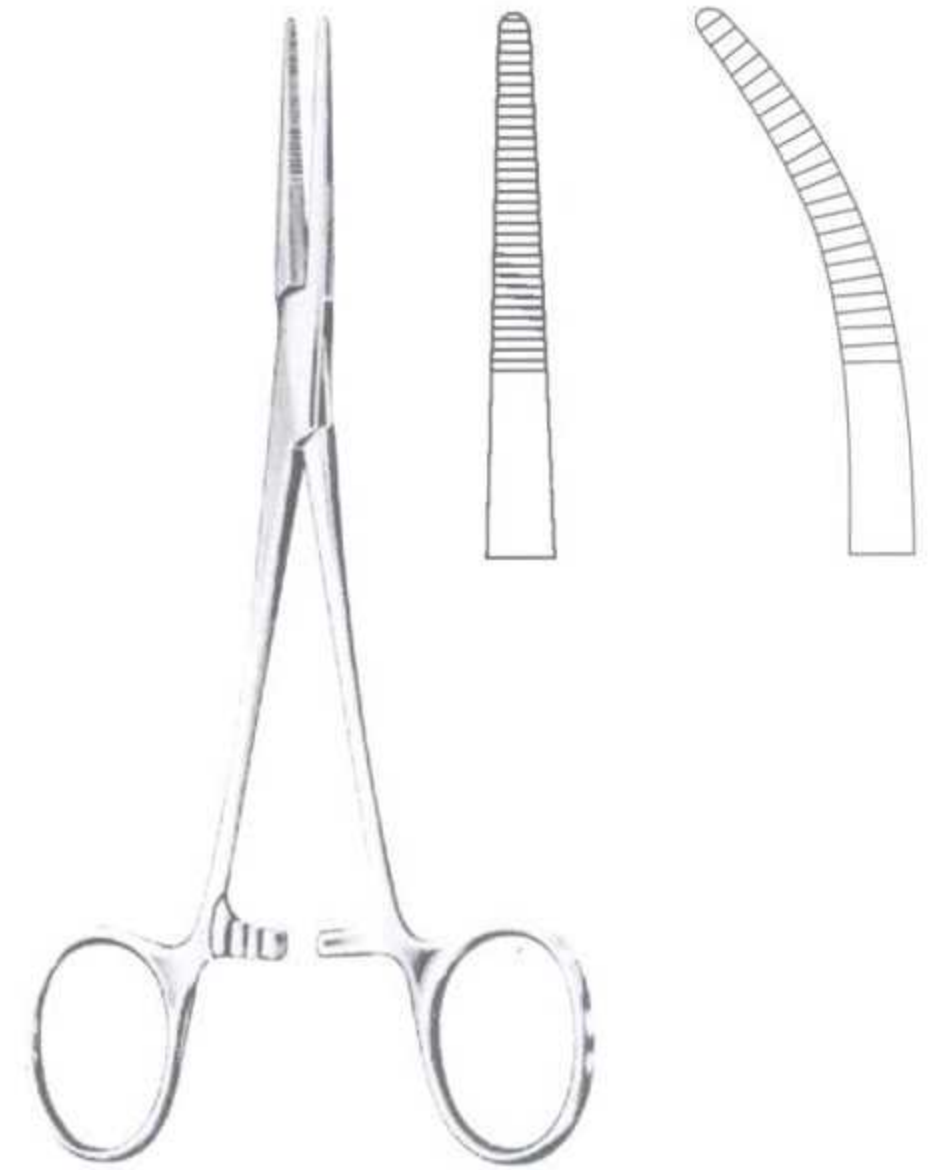

KELLY
NE - 074-05 5 1/2"
NE - 075-05 5 1/2"



RANKIN KELLY
NE - 076-06 6 1/4"
NE - 077-06 6 1/4"



CRILE
NE - 078-05 5 1/2"
NE - 079-05 5 1/2"



RANKIN CRILE
NE - 080-05 6 1/4"
NE - 081-05 6 1/4"



HEMOSTATICS FORCEPS

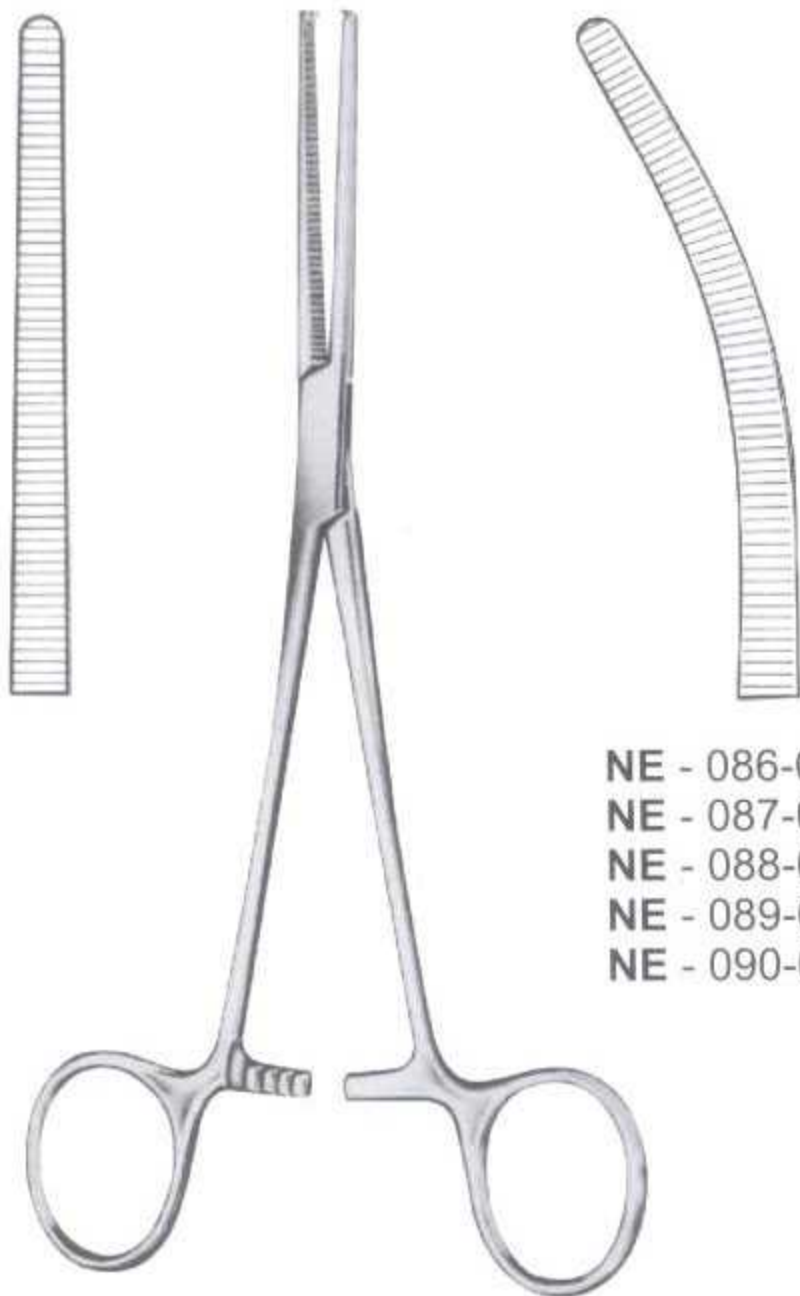

- NE - 086-05 5 1/2"
- NE - 087-06 6 1/4"
- NE - 088-07 7 1/4"
- NE - 089-08 8"
- NE - 090-09 9"

ROCHESTER / PEAN

- NE - 082-05 5 1/2"
- NE - 083-06 6 1/4"
- NE - 084-07 7 1/4"
- NE - 085-08 8"
- NE - 085-09 9"



- NE - 095-05 5 1/2"
- NE - 096-06 6 1/4"
- NE - 097-07 7 1/4"
- NE - 098-08 8"

ROCHESTER / OCHSNER

- NE - 091-05 5 1/2"
- NE - 092-06 6 1/4"
- NE - 093-07 7 1/4"
- NE - 094-08 8"

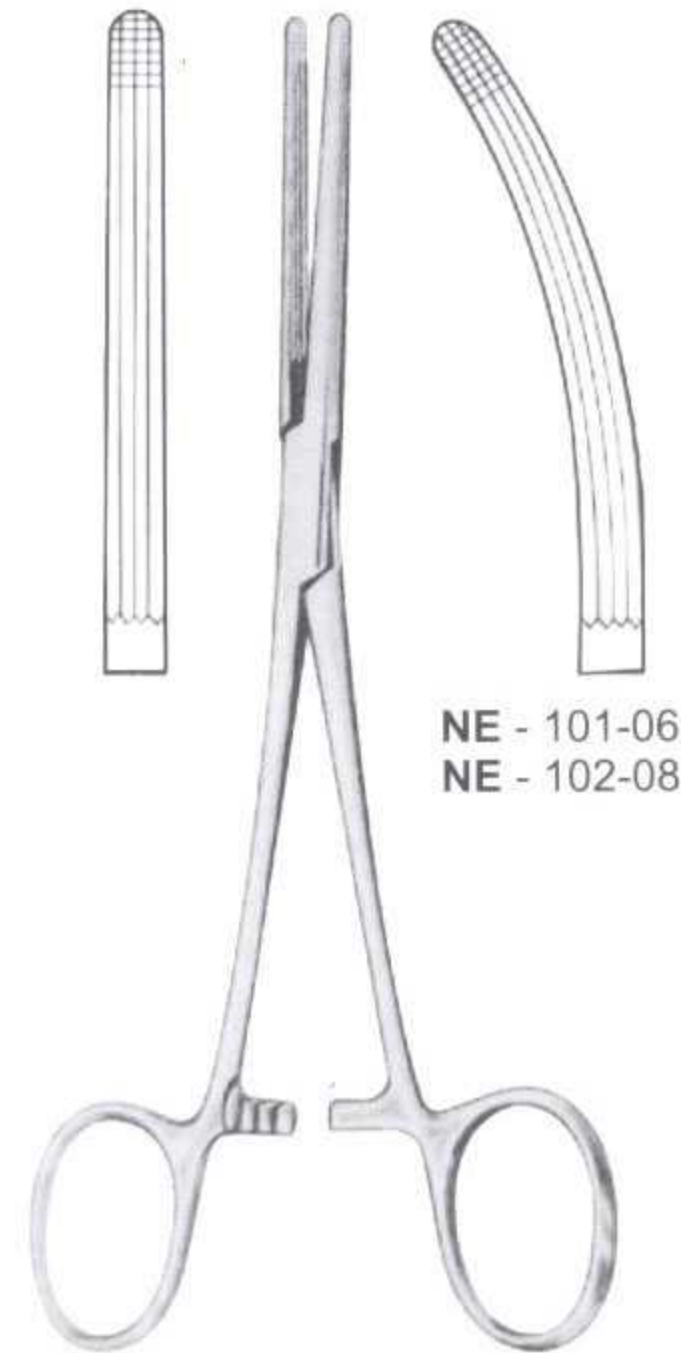

- NE - 101-06 6 1/4"
- NE - 102-08 8"

ROCHESTER / CARMALT

- NE - 099-06 6 1/4"
- NE - 100-08 8"

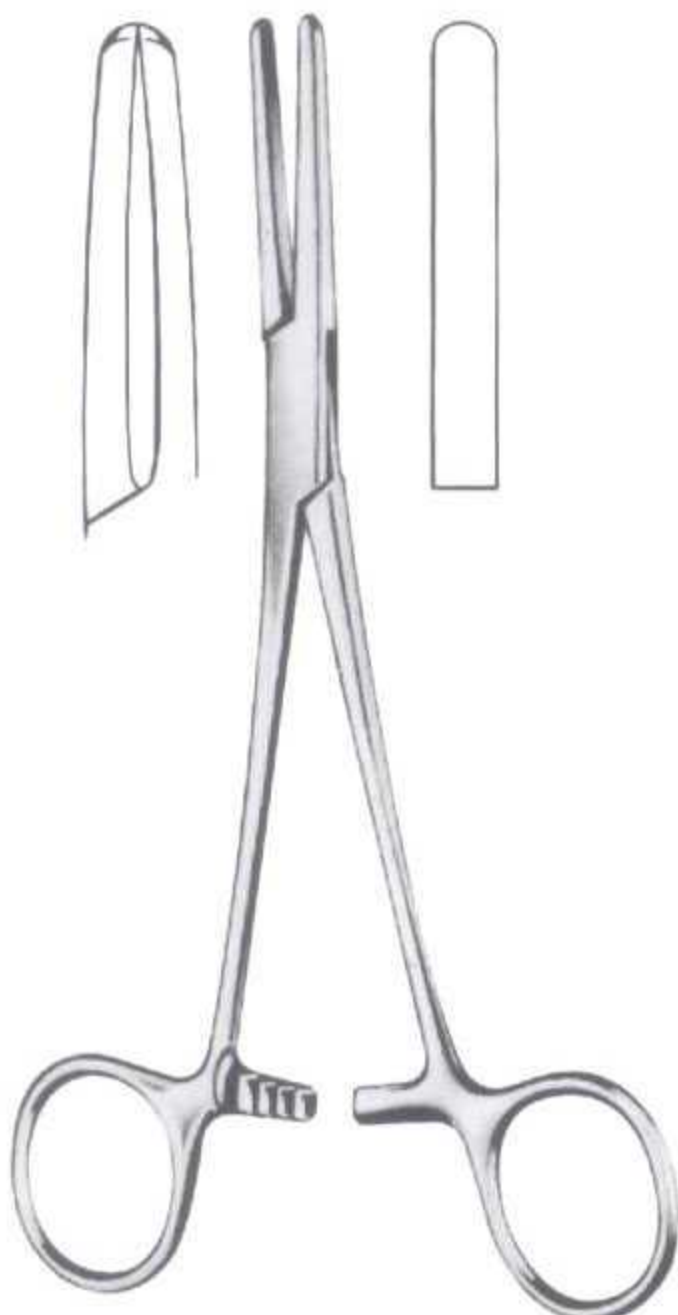

TUBE OCCLUDING (PLAIN)

- NE - 103-05 5 1/2"
- NE - 104-07 7"

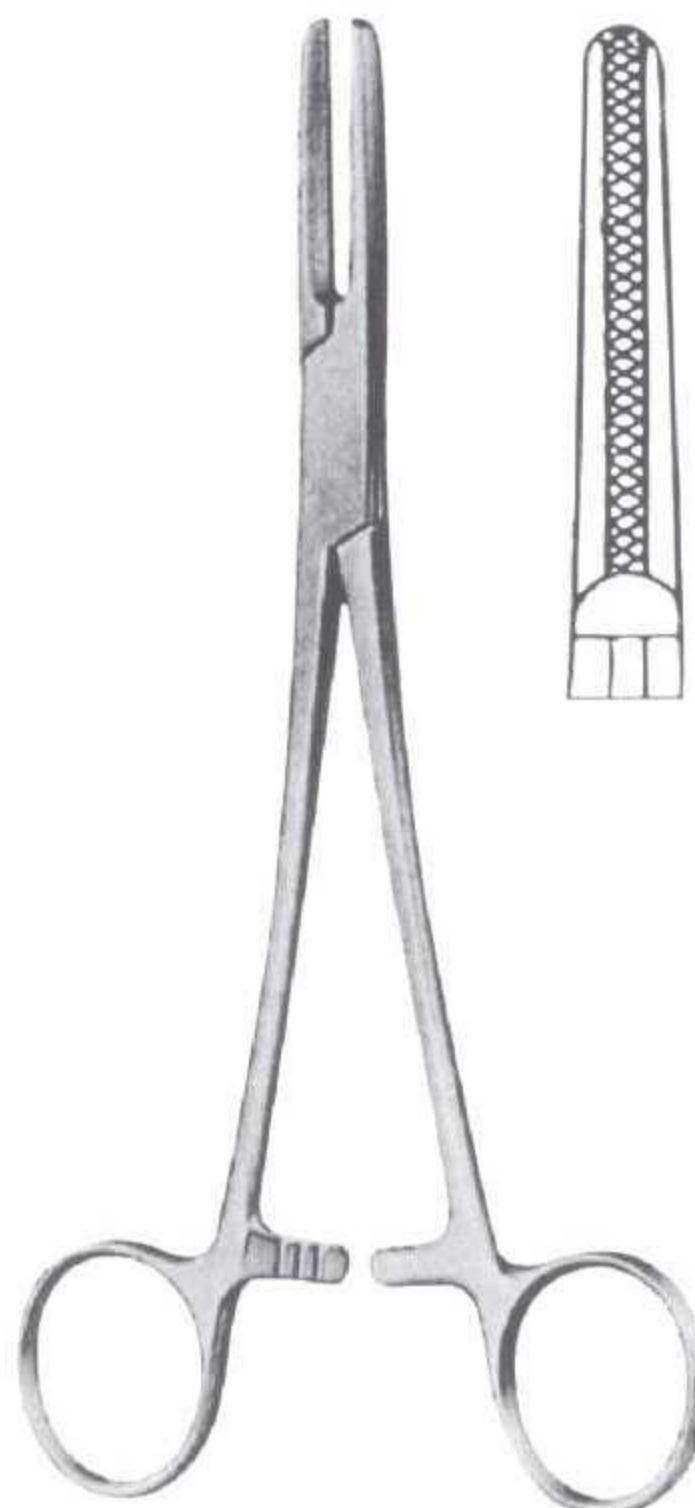

TUBE OCCLUDING (SERRATED)

- NE - 105-05 5 1/2"
- NE - 106-07 7"



TUBE OCCLUDING (SERRATED) WITH TUBING GUARD

- NE - 107-07 7"

HEMOSTATIC FORCEPS



**HARTMAN MASQUITO
(DELICATE) Fine Point**

NE -108-03 3½" (Str)
NE -109-03 3½" (Crvd)



**HALSTED MASQUITO
(DELICATE) Fine Point**

NE -110-0F 3½" (Str)
NE -111-0F 3½" (Crvd)



**HALSTED MASQUITO
Masquito Micro**

NE -110-0M 5" (Str)
NE -111-0M 5" (Crvd)

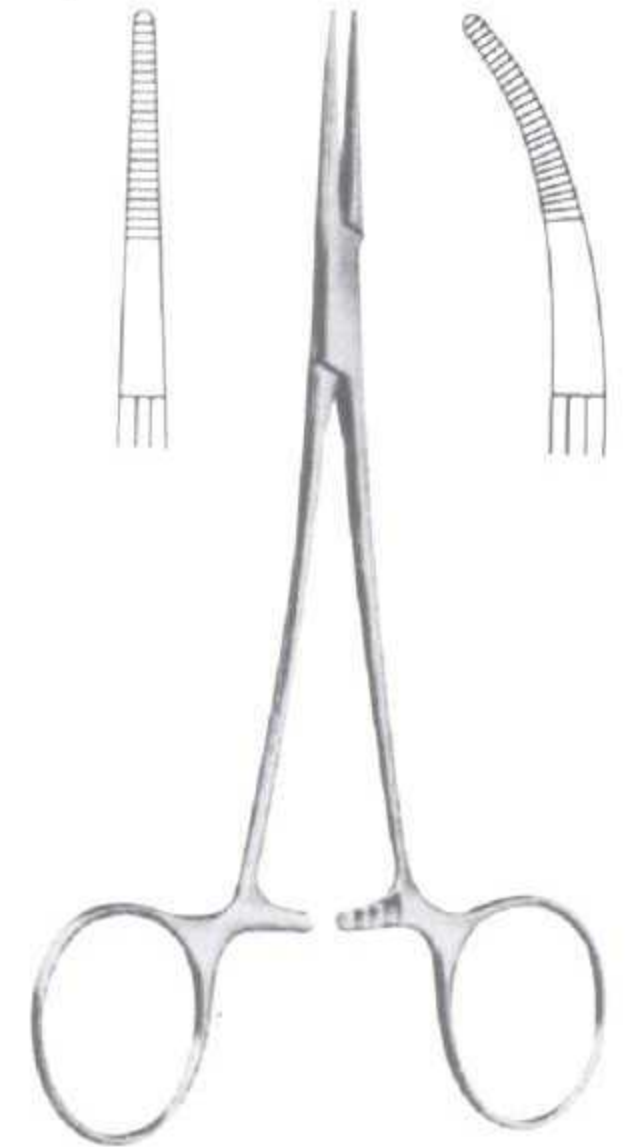

**HARTMAN MASQUITO
Providence Hospital**

NE -112-0P 5½" (Str)
NE -113-0P 5½" (Crvd)

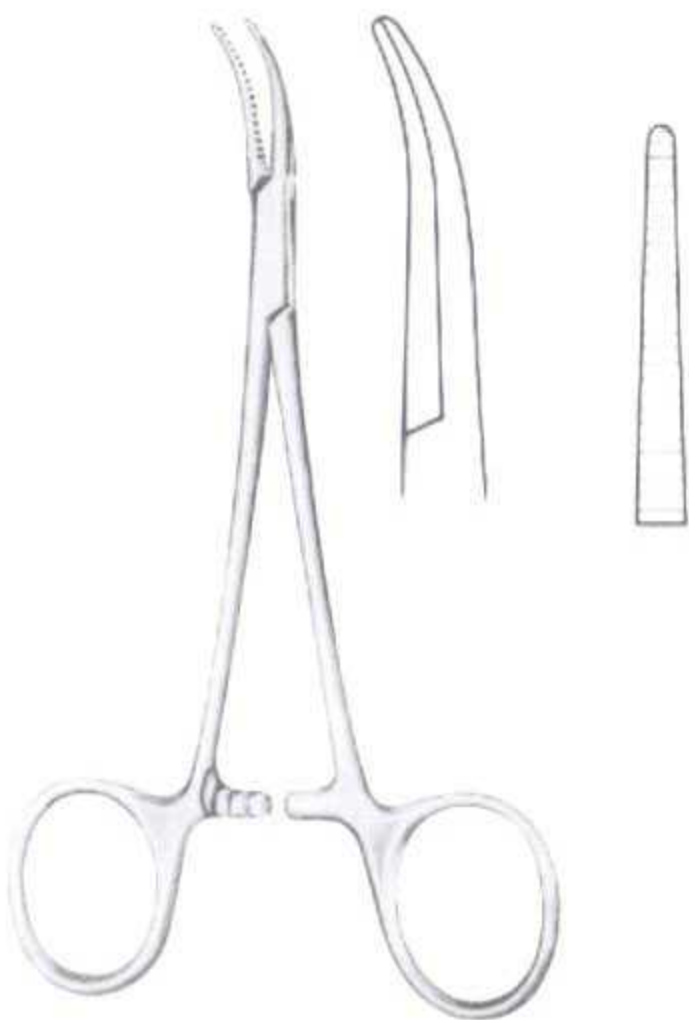

DANDY

NE -114-0A 5½"



BABY-MIXTER

NE -115-0B 5½"

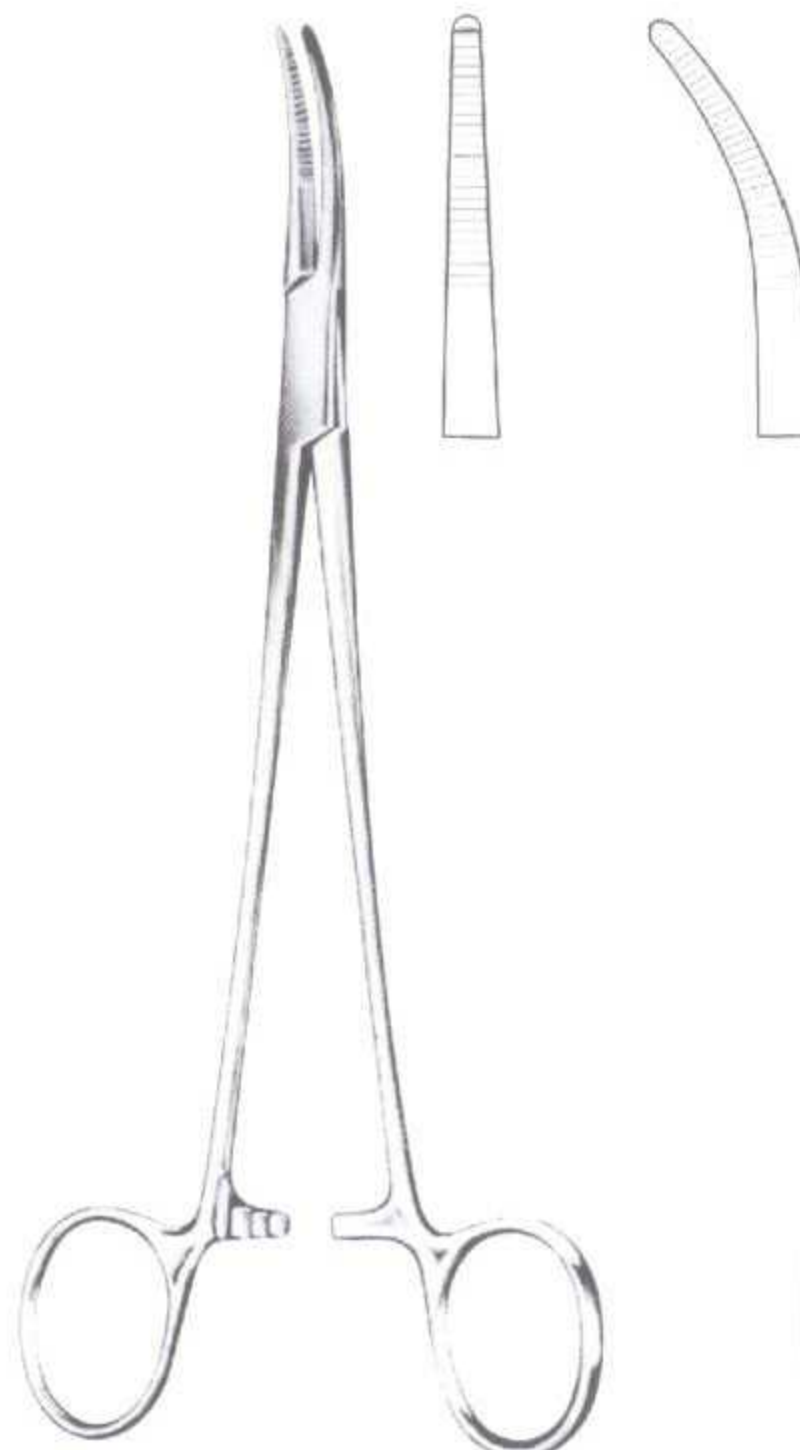

ADSON

NE -116-07 7½"
NE -117-07 7½"



MIXTER

NE -118-08 8½"



NEEDLE HOLDERS

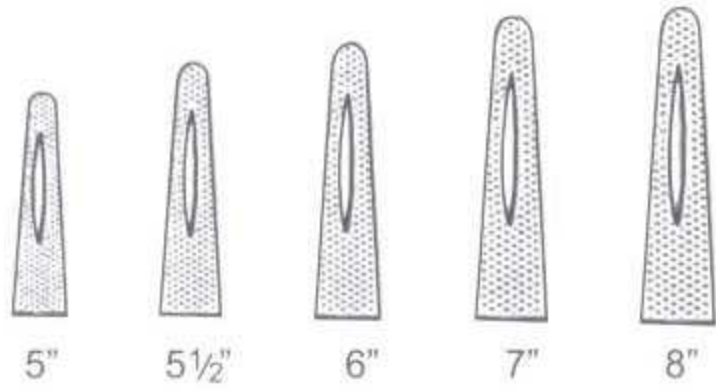

MAYO-HEGAR

- NE -121-05 5"
- NE -122-05 5 1/2"
- NE -123-06 6"
- NE -124-07 7"
- NE -125-08 8"



BAUMGARTNER

- NE -126-05 5"
- NE -127-05 5 1/2"
- NE -128-06 7"



WEBSTER

- NE -129-04 4 1/2"
- NE -130-04 5 3/4"
- NE -131-05 5"
- NE -132-05 5 1/2"



MOSQUITO WEBSTER

- NE -133-05 5"

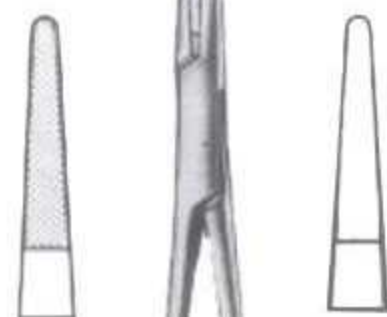
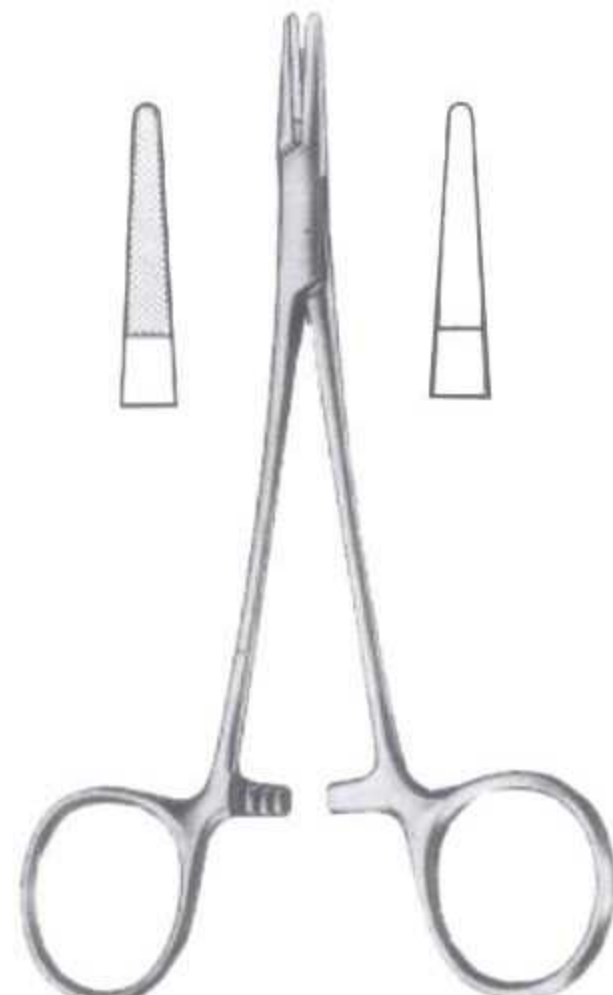

HALSEY

- NE -134-05 5"
- NE -134-06 6"



DERF

- NE -135-04 4 3/4"

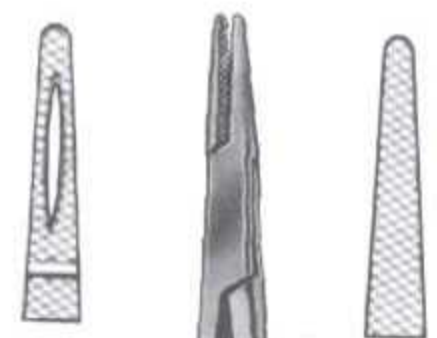

CRILE-WOOD

- NE -136-04 6"

NEEDLE HOLDERS & TOWEL CLAMP



COLLIER
NE -137-05 5"



OLSEN HEGAR
NE -138-05 5½"
NE -139-06 6½"
NE -140-07 7½"



NE -145-05 5½"
NE -146-06 6¾"
NE -147-08 8"
NE -148-09 9½"



MICHEL
NE -149-05 5"

MATHIEU
NE -141-05 5½"
NE -142-06 6¾"
NE -143-08 8"
NE -144-09 9½"



BACKHAUS
NE -151-03 3½"
NE -152-05 5¼"



ROEDER
NE -153-05 5¼"



JONES
NE -154-03 3¼"

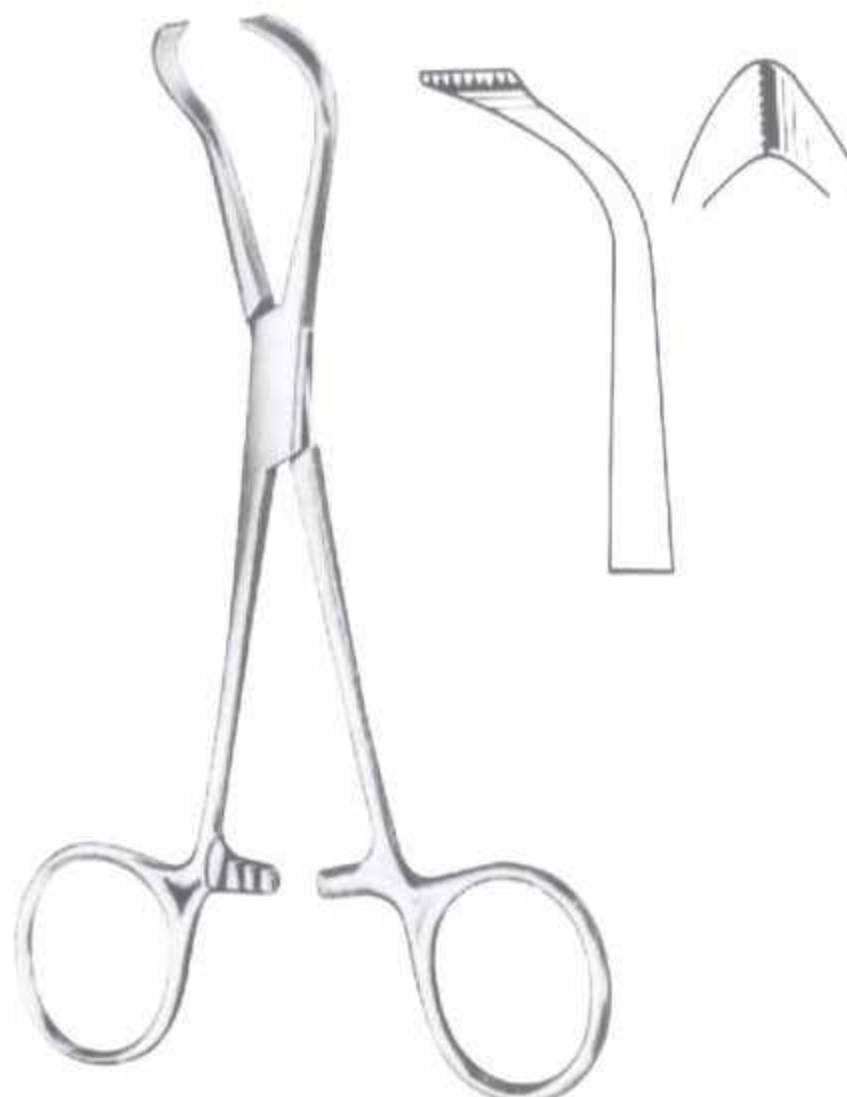

LORNA
NE -155-03 3½"
NE -155-05 5¼"



HOFF
NE -156-03 3½"
NE -157-04 5¼"



SPONGE HOLDINGS, TENACULUM, STERILIZERS



STERILIZER 1/2 PRONGS

NE -158-08 8"
NE -159-11 11"

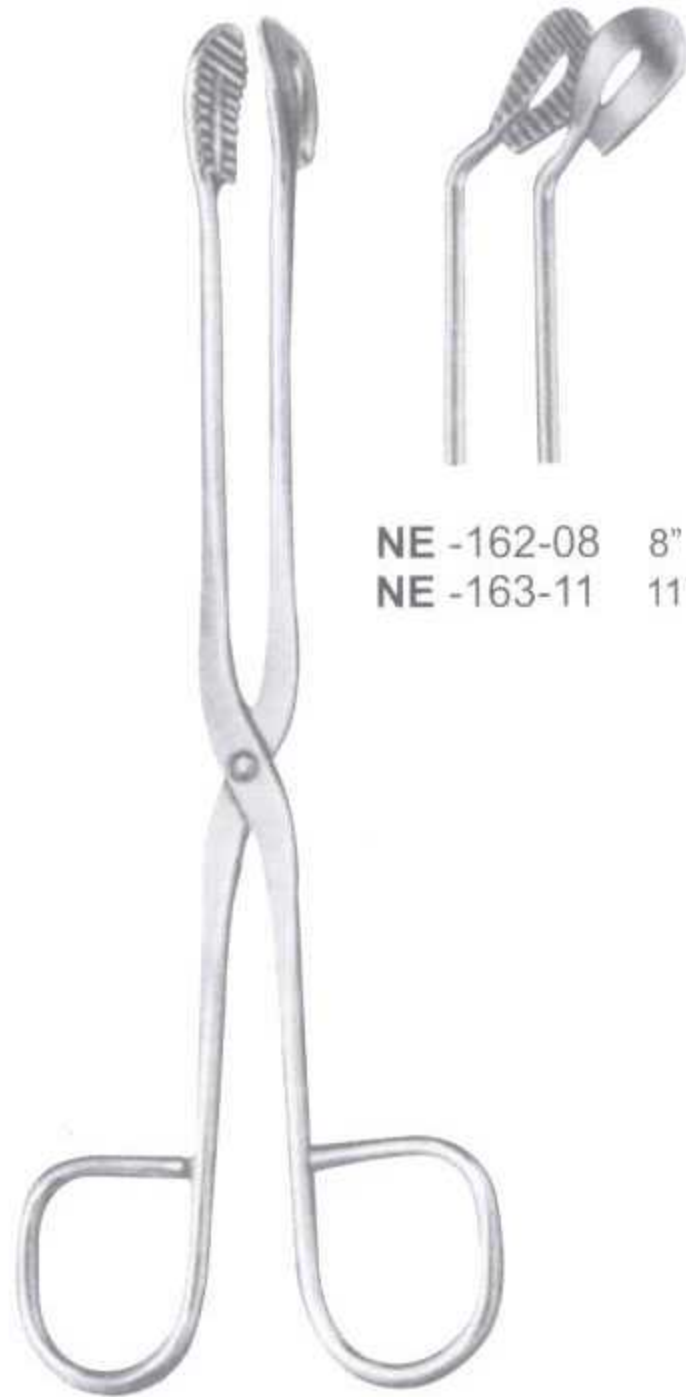

UNIVERSAL

NE -160-08 8"
NE -161-11 11"

NE -162-08 8"
NE -163-11 11"

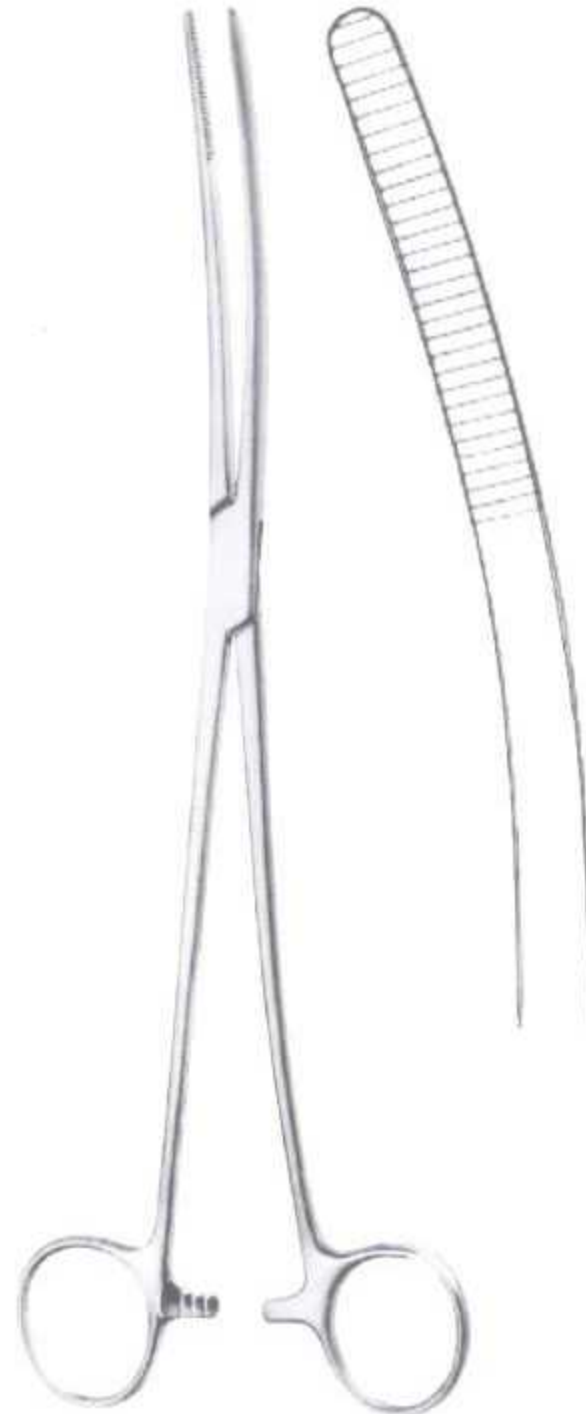

BOZEMANN

NE -164-10 10 1/4" STR
NE -165-10 10 1/4" CUR



SCHROEDER TENACULUM

NE -166-09 9 1/2"

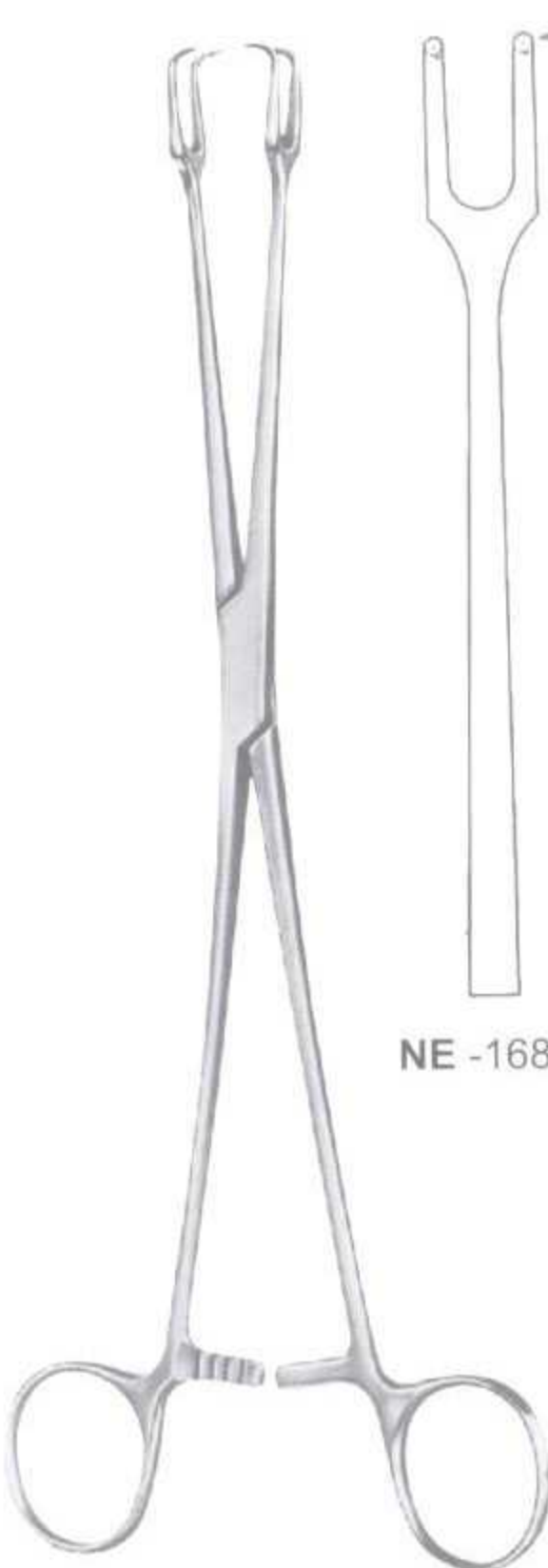

SCHROEDER TENACULUM

NE -167-09 9"
NE -168-09 9"
NE -169-09 9"

NE -168-09

NE -169-09

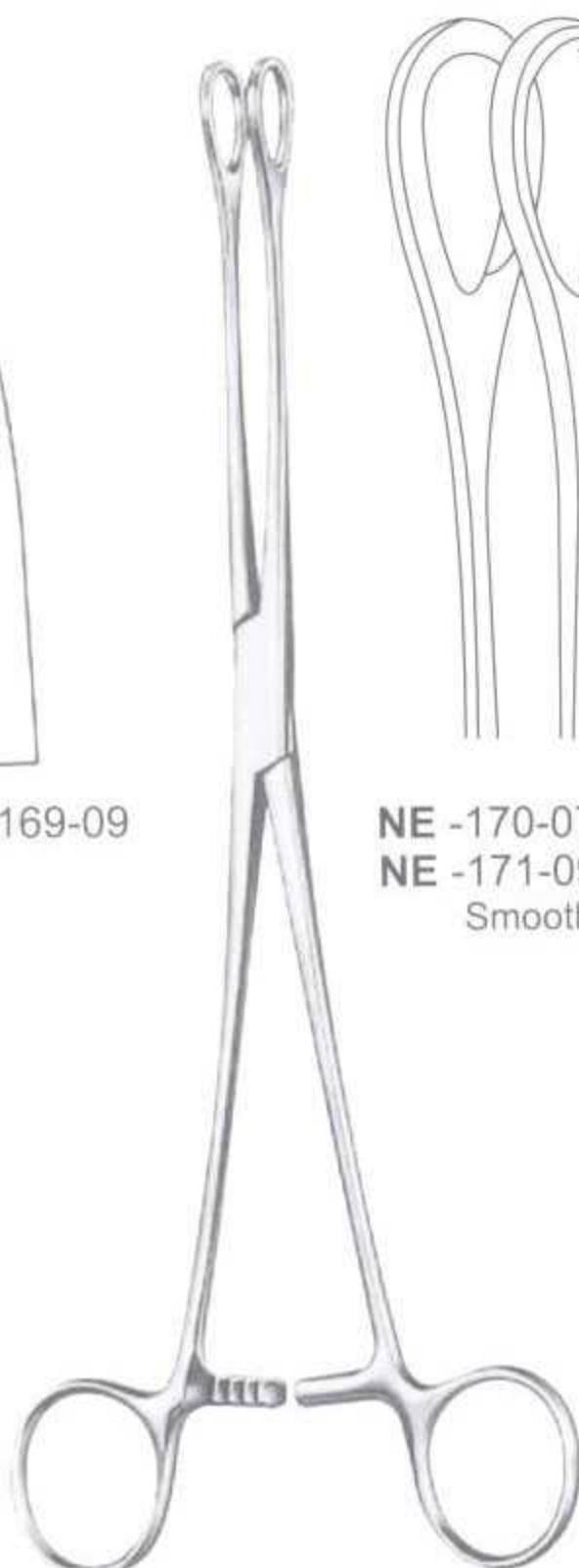

BALLENGER / FOESTER

NE -170-07 7"
NE -171-09 9 1/2"
Smooth

NE -172-07 7"
NE -173-09 9 1/2"
Serrated

NE -174-07 7"
NE -175-09 9 1/2"
Smooth

NE -176-07 7"
NE -177-09 9 1/2"
Serrated

HEMOSTATIC FORCEPS



BABY-ALLIS
 NE -178-B1 5¼"
 NE -178-B2 5¼"
 NE -178-B3 5¼"

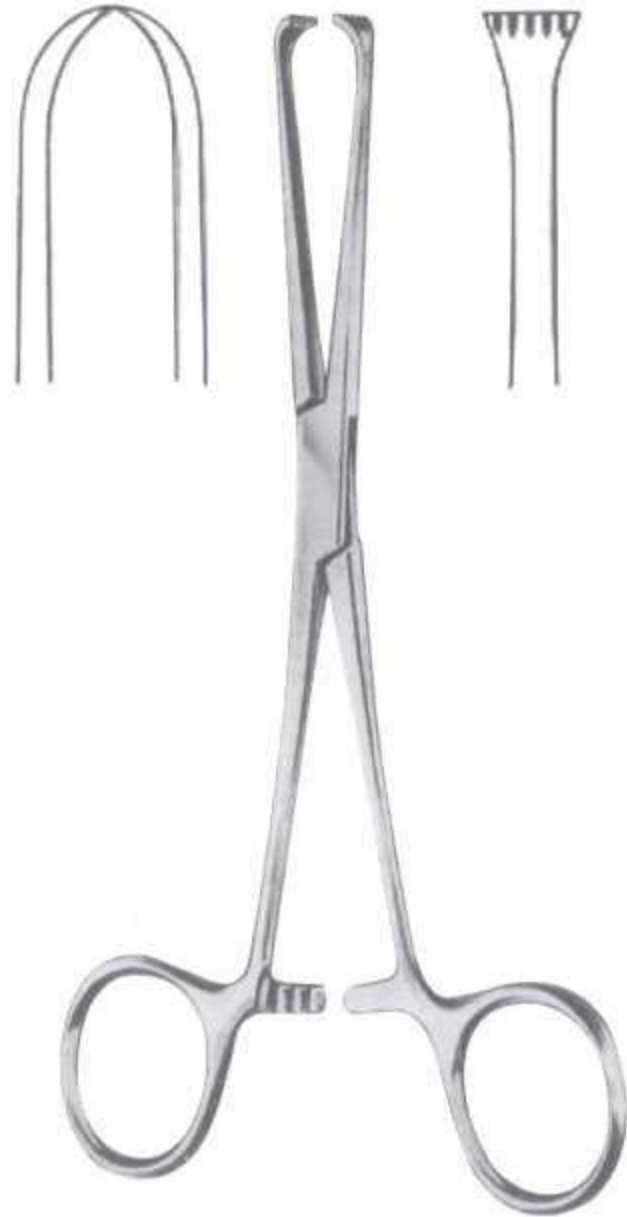

ALLIS
 NE -179-06 6"
 NE -180-06 6"
 NE -181-06 6"
 NE -182-07 7"



THOMAS GAYLOR
 NE -183-08 8¾"
 NE -184-09 9½"



MCKENZIE
 NE -185-08 8"

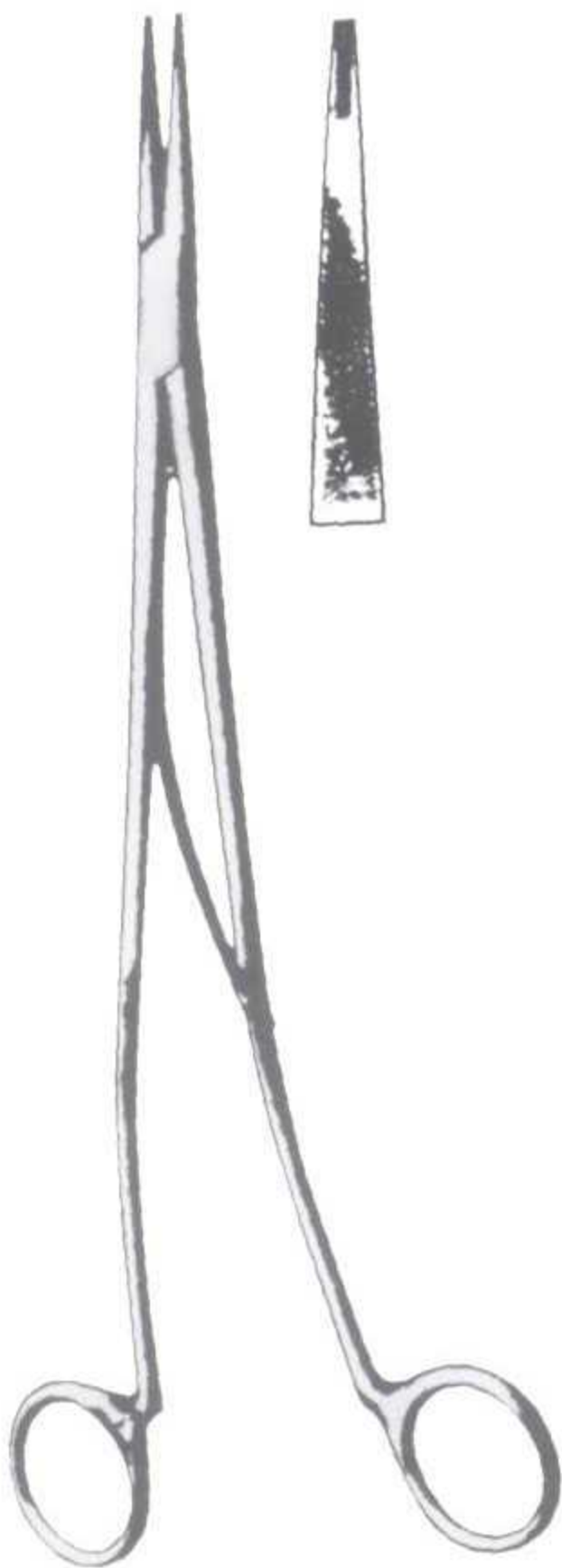

SWEET
 NE -186-09 9"
 NE -187-10 10½"



SMITHWICK
 NE -188-09 9"
 NE -189-10 10½"



MCKENZIE
 NE -190-08 8"



TUBES, HOOKS PROBES

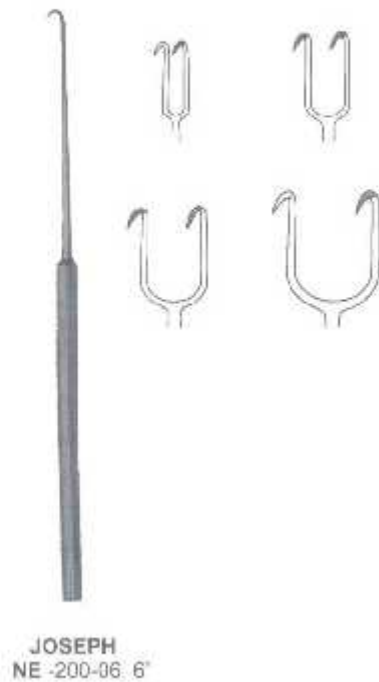

DRESSING TISSUE



THUMB

- NE -204-04 4 1/2"
- NE -205-05 5"
- NE -206-05 5 1/2"
- NE -207-06 6"
- NE -208-08 8"
- NE -209-10 10"
- NE -210-12 12"



THUMB (With Pin)

- NE -211-04 4 1/2"
- NE -212-05 5"
- NE -213-05 5 1/2"
- NE -214-06 6"
- NE -215-08 8"
- NE -216-10 10"
- NE -217-12 12"



TISSUE

- NE -218-04 4 1/2"
- NE -219-05 5"
- NE -220-05 5 1/2"
- NE -221-06 6"
- NE -222-08 8"
- NE -223-10 10"
- NE -224-12 12"



SEMKEN

- NE -225-04 4 3/4"
- NE -226-0A 6"



SEMKEN

- NE -227-04 4 3/4"
- NE -228-0A 6"



POOTS-SMITH



- NE -229-02 7" NE -229-05 7"
- NE -229-03 8" NE -229-06 8"
- NE -229-04 10" NE -229-07 10"



ADSON NE -230-04 (1 X 2 Teeth)

- NE -230-04 4 3/4"
- NE -230-0F 4 3/4"
- Fine Point



ADSON (Serrated) NE -231-04 4 3/4"



ADSON-BROWN (Serrated) NE -232-04 4 3/4" NE -232-0F 4 3/4"



RUSSIAN NE -233-06 6" NE -233-08 8" NE -233-08 10"



EYE DRESSING SPLINTER



IRIS



NE -234-01



NE -235-01



NE -236-01



NE -237-01



NE -238-01



NE -239-01



NE -240-01
1½"



NE -240-02
1½"



NE -240-03
2½"



NE -240-04
2½"

DEIFFENBACH-SERREFINE FORCEPS



SPLINTER
NE -241-03 3½"
NE -242-04 4½"



FEILCHENFELD
NE -243-03 3½"
NE -244-04 4½"



HUNTER
NE -245-01 4"



HUNTER
NE -246-02 4"



CARMALT
NE -246-01 4½"
NE -246-02 4½"



246-02



VIRTUS
NE -247-06 6"



VIRTUS
NE -248-06 6"
(Angled)

EYE DRESSING CILIA



DELICATE



IRIS



NE -249-0F



NE -250-0F



NE -251-0F



NE -252-0F



NE -253-0F



NE -254-0F



GRAEFE
NE -255-04 4 1/4"



GRAEFE
NE -256-04 4 1/4"



BISHOP-HARMAN
NE -257-03 3 1/4" (Serrated)
NE -258-03 3 1/4" (1 x 2 Teeth)



NE -259-01 6 1/4"
NE -259-02 7 3/4"
1.5 mm
Jaws



DE BAKEY

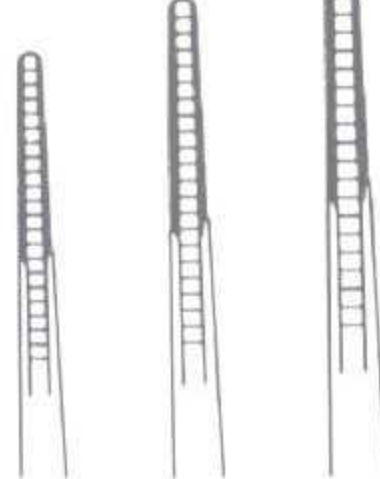

NE -259-03 6 1/4"
NE -259-04 7 3/4"
NE -259-05 9 1/2"
2.0 mm
Jaws

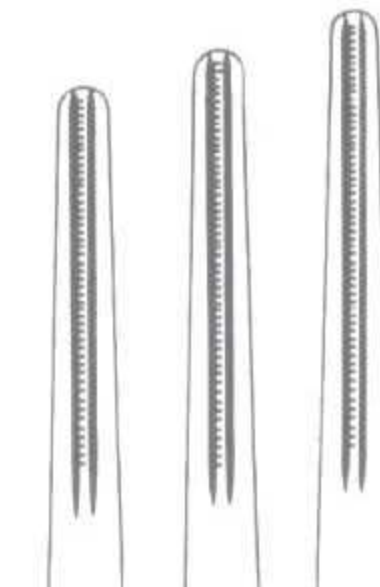

NE -259-06 6 1/4"
NE -259-07 7 3/4"
NE -259-18 9 1/2"
3.0 mm
Jaws



DOUGLASS
NE -260-10 3 1/2"



BEER
NE -261-11 3 1/2"



ZIEGLER
NE -262-12 3 1/2"



LITTAUER
NE -263-13 3 1/2"



BERGH
NE -263-14 3 1/2"



NE -265-03 3"



NE -264-03 3"



CURETTES MIRROR HANDLE

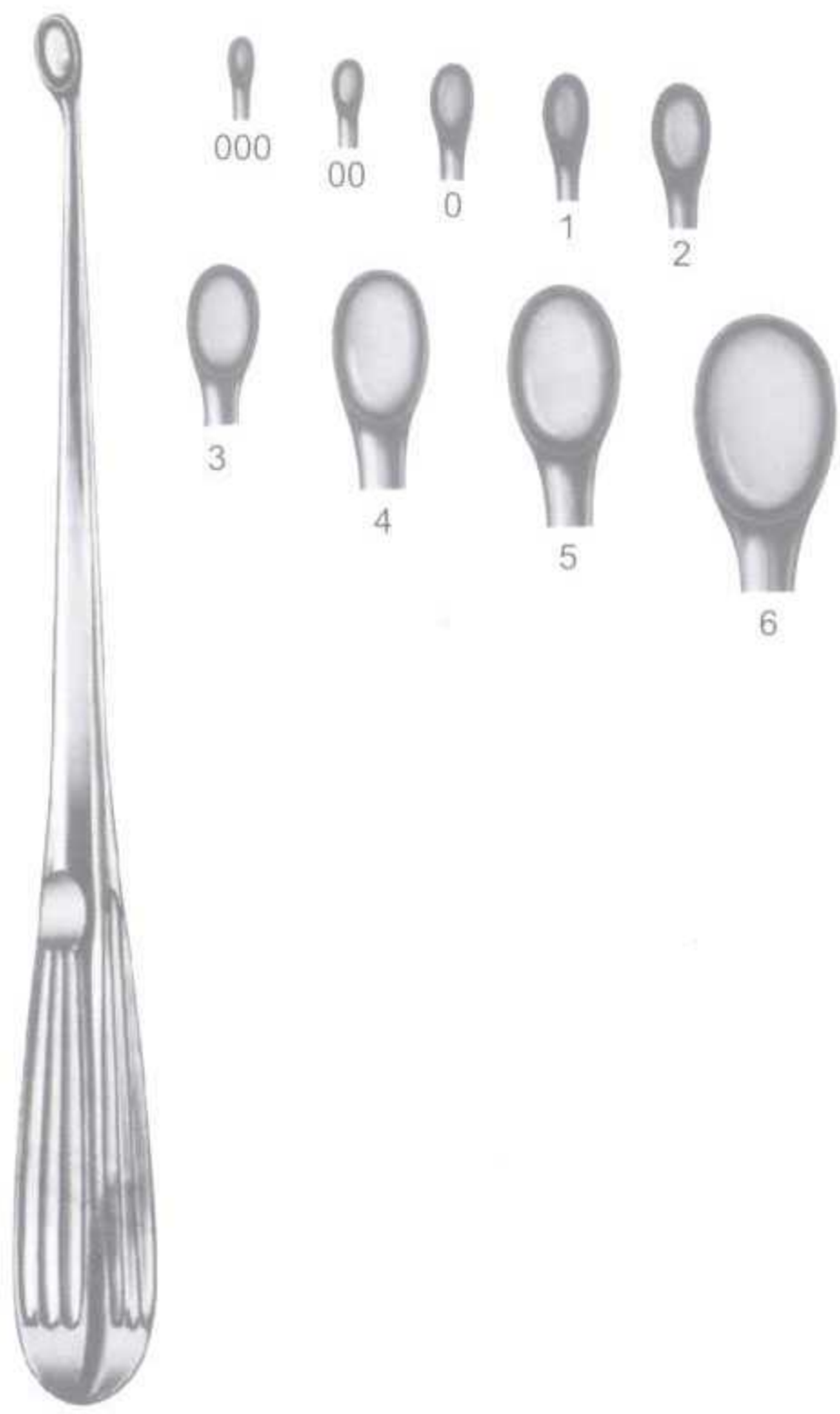

BRUNS
NE -266-07 7"
Fig. 000 to 6



VOLKMAN
NE -267-08 6 1/2"
NE -268-08 8"



VOLKMAN
NE -269-08 6 1/2"



RANDALL
NE -270-08 9 1/4"



NOVAK
NE -271-08 9 1/4"



BOUCHERON
NE -272-14 (Fig.1 to 4)
NE -273-15 (Fig.5 to 4)

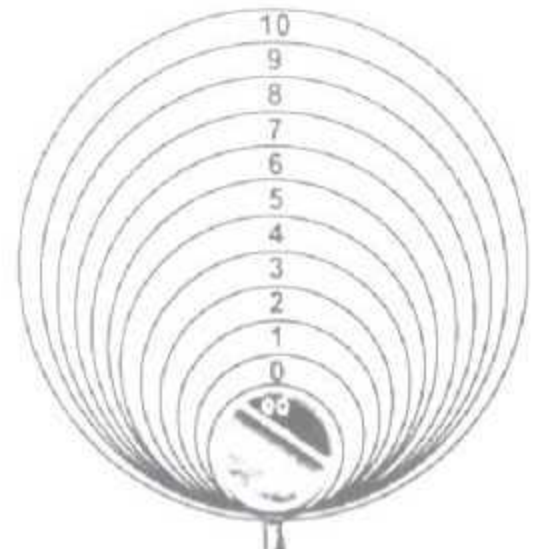

NE -274-08 (Fig.00 to 10)
SIZE: 8 mm to 30 mm



MIRROR



MIRROR WITH HANDLE
NE -275-07 8 1/4"



HANDLE
NE -276-18



HANDLE
NE -277-19

EAR INSTRUMENTS



LUCAE
NE -278-05 5 1/2"



WILDE
NE -279-05 5"
NE -280-05 5"



HARTMAN ALLIGATOR
NE -281-01 SFT 3"
NE -281-02 SFT 3 1/2"
NE -281-03 SFT 3 1/2"
NE -281-04 SFT 3 1/2"
NE -281-05 SFT 3"
NE -281-06 SFT 3 1/2"
DELICATE



CHROME
NE -282-01 2 OZ
NE -282-02 3 OZ
NE -282-03 4 OZ
NE -282-04 6 OZ
NE -282-05 8 OZ



PIMEORY SYRINGE

TUNNING FORKS



NE -282-01



NE -282-02



NE -282-03



NE -282-04



NE -282-05

EXTRACTORS

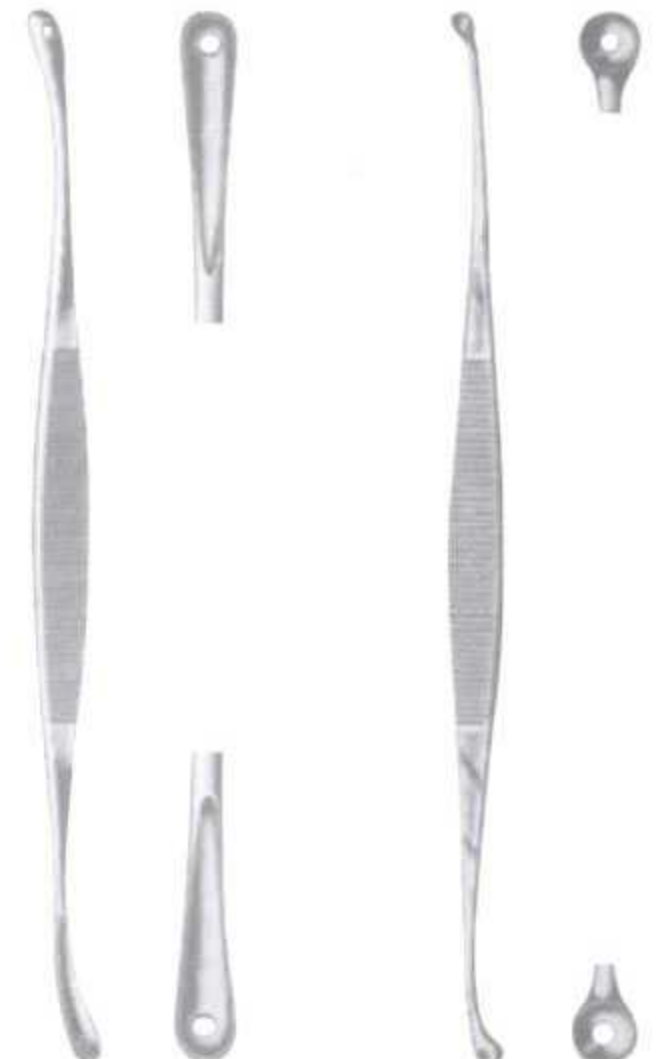

UNNA
NE -283-06
14 cm

UNNA
NE -284-07
14 cm



NAZAL TONGUE INTESTINAL



VIENNA
 NE -285-01 SMALL (INFANT)
 NE -285-02 MEDIUM (CHILD)
 NE -285-03 LARGE (ADULT)



NOYES
 NE -286-01 Serrated
 NE -286-02 (1 x 2 Teeth)



YOUNG
 NE -287-06 6 1/2"
 NE -287-08 8"



YOUNG
 NE -288-08 8"
 Pennington



BABCOCK
 NE -289-06 6 1/4"
 NE -290-08 8 3/4"

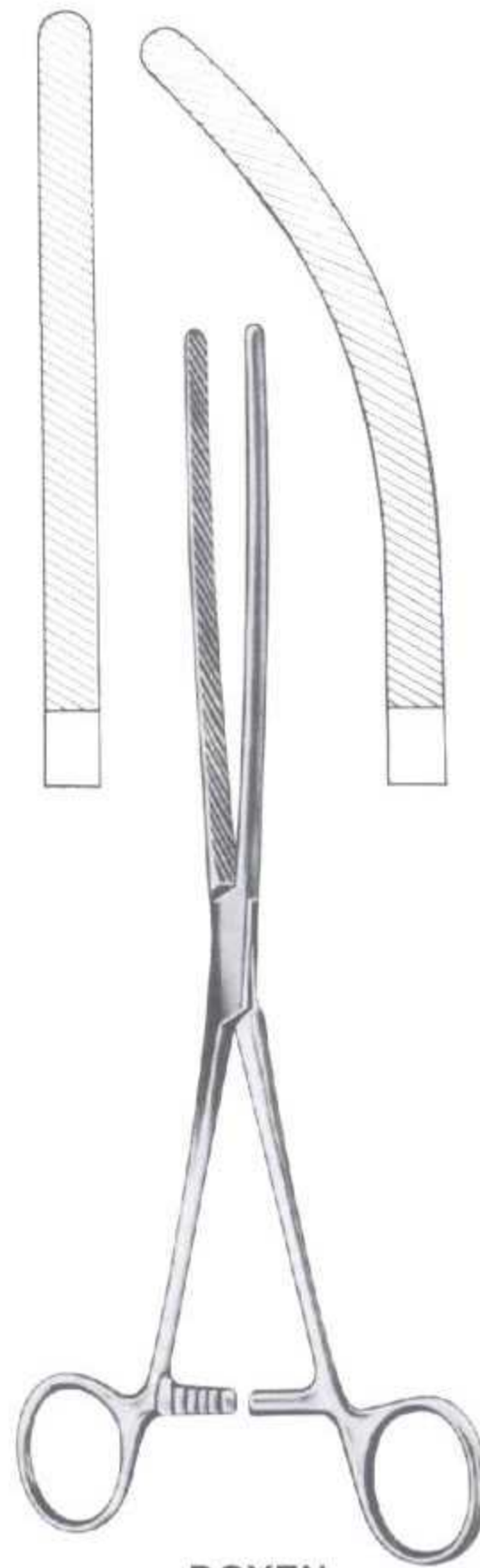

DOYEN
 NE -291-06 9"
 NE -292-08 9"

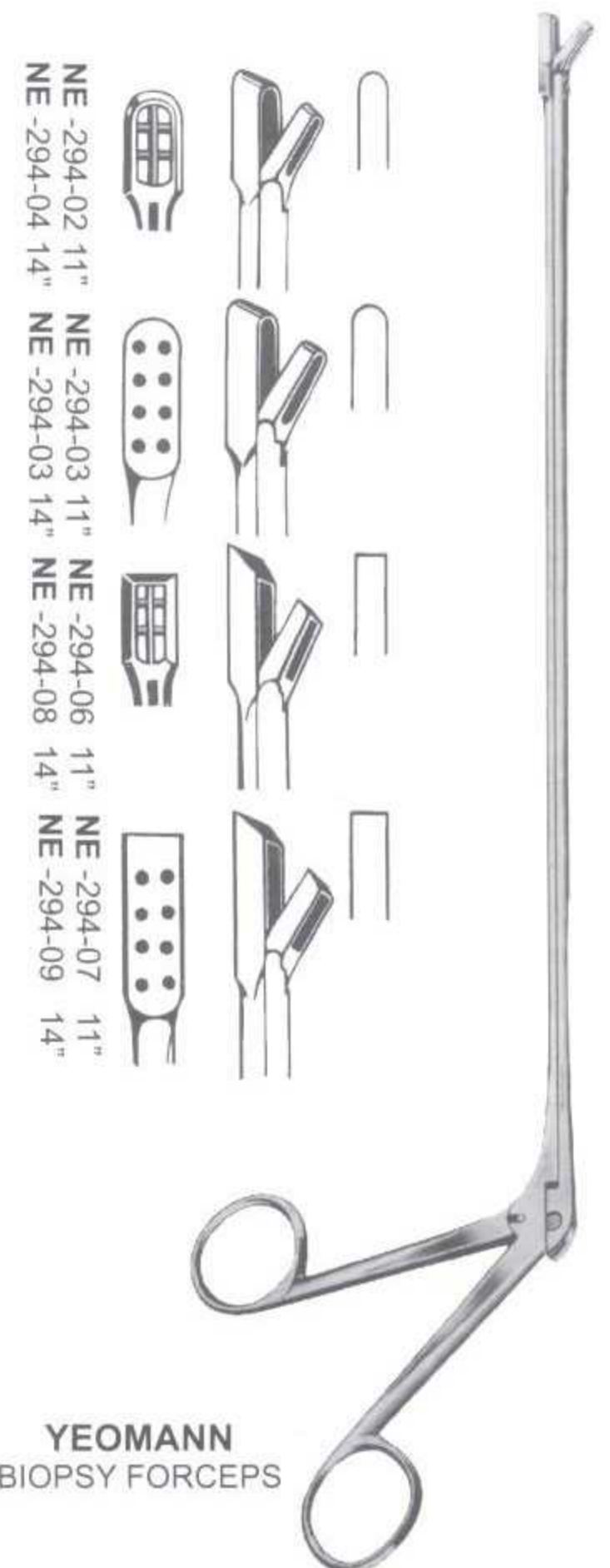

YEOMANN
 BIOPSY FORCEPS

NE -294-02 11"
 NE -294-04 14"
 NE -294-03 11"
 NE -294-03 14"
 NE -294-06 11"
 NE -294-08 14"
 NE -294-07 11"
 NE -294-09 14"

SCALPAL HANDLE & PROBES



NE-295-03
NO.3



NE-297-0R



NE-298-3L
NO.3L



NE-299-04
NO.4



NE-300-04
NO.4L



NE-301-07
NO.7



COLLIN
NE-302-09
NO.9



NE-302-34
Double Handle
Number 4 + Number 5



NE-303-01 5"
NE-303-02 5½"
NE-303-03 6"
NE-303-04 8"

PROBE



EYE PROBE

NE-304-01 4½"
NE-304-02 5"
NE-304-03 5½"
NE-304-04 6"
NE-304-05 8"
NE-304-06 10"
NE-304-07 12"



TONGUE TIE

NE-305-01 5"
NE-305-02 5½"
NE-305-03 6"



TONGUE TIE
W / PROBE

NE-306-01 5"
NE-306-02 5½"
NE-306-03 6"



BULE
NE-307-06 6¼"



NEEDLE
NE-308-05 5½" STR
NE-308-05 5½" CUR

25°



SCALPEL
NE-308-05 7"



SPECULUM & DELATORS



GRAVES
 NE-309-01 Small
 NE-309-02 Medium
 NE-309-03 Large



PEDERSON
 NE-310-01 Small
 NE-310-02 Medium
 NE-310-03 Large



TROUSSEAU
 NE-311-05 5 1/2"



KOGAN
 NE-312-09 9 1/2"

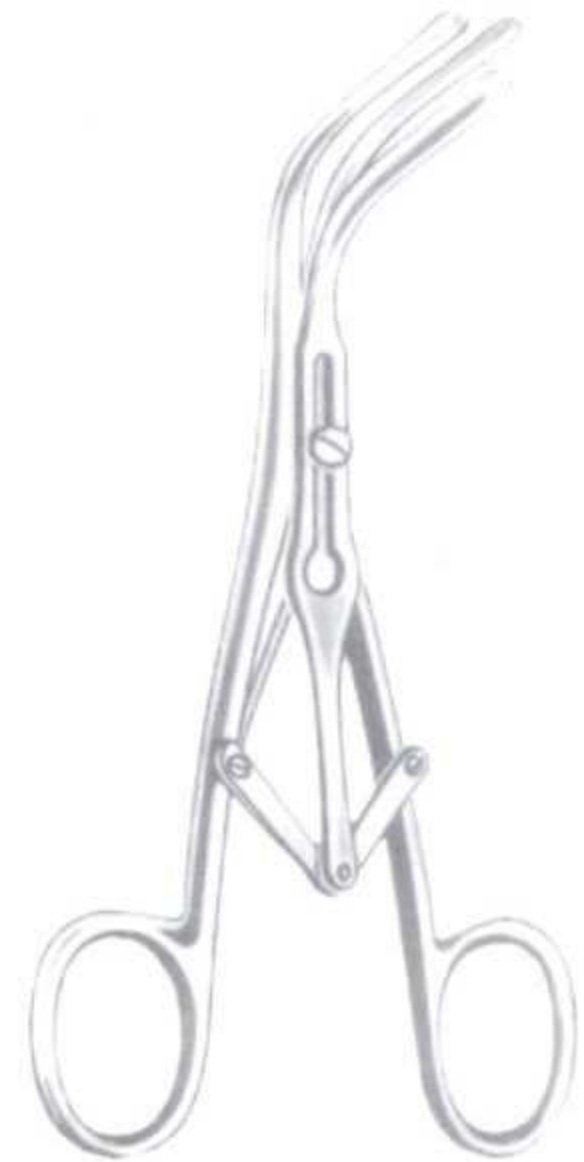

LABORDE
 NE-313-05 5 1/2"



HEGAR
 NE-313-00
 Set of (3 to 4mm - 17 to 18mm)
 in cloth roll
 NE-313-01
 Set of (3 to 4mm - 17 to 18mm)
 in plastic soft zip case



HANK
 NE-313-02
 Set of 6
 (9/10 to 19/20)



PRATT
 NE-313-03
 Set of 8
 (13/15 FR. To 41/43 FR.)



SIMS
 NE-314-01 12 1/2"
 NE-315-02 12 1/2"



SIMPSON
 NE-316-01 12 1/2"
 NE-317-02 12 1/2"

RETRACTORS, CLAMPS



ALM
 NE-317-01 2 3/4" (Sharp)
 NE-317-02 4" (Sharp)
 NE-318-01 2 3/4" (Blunt)
 NE-318-02 4" (Blunt)



HEISS
 NE-319-01 4" (Blunt)
 NE-319-02 4" (Blunt)



MOGAN
 NE-320-00



GUMCO
 NE-321-06 8mm
 NE-321-07 11mm
 NE-321-08 13mm
 NE-321-09 16mm
 NE-321-10 21mm
 NE-321-11 26mm
 NE-321-12 32mm

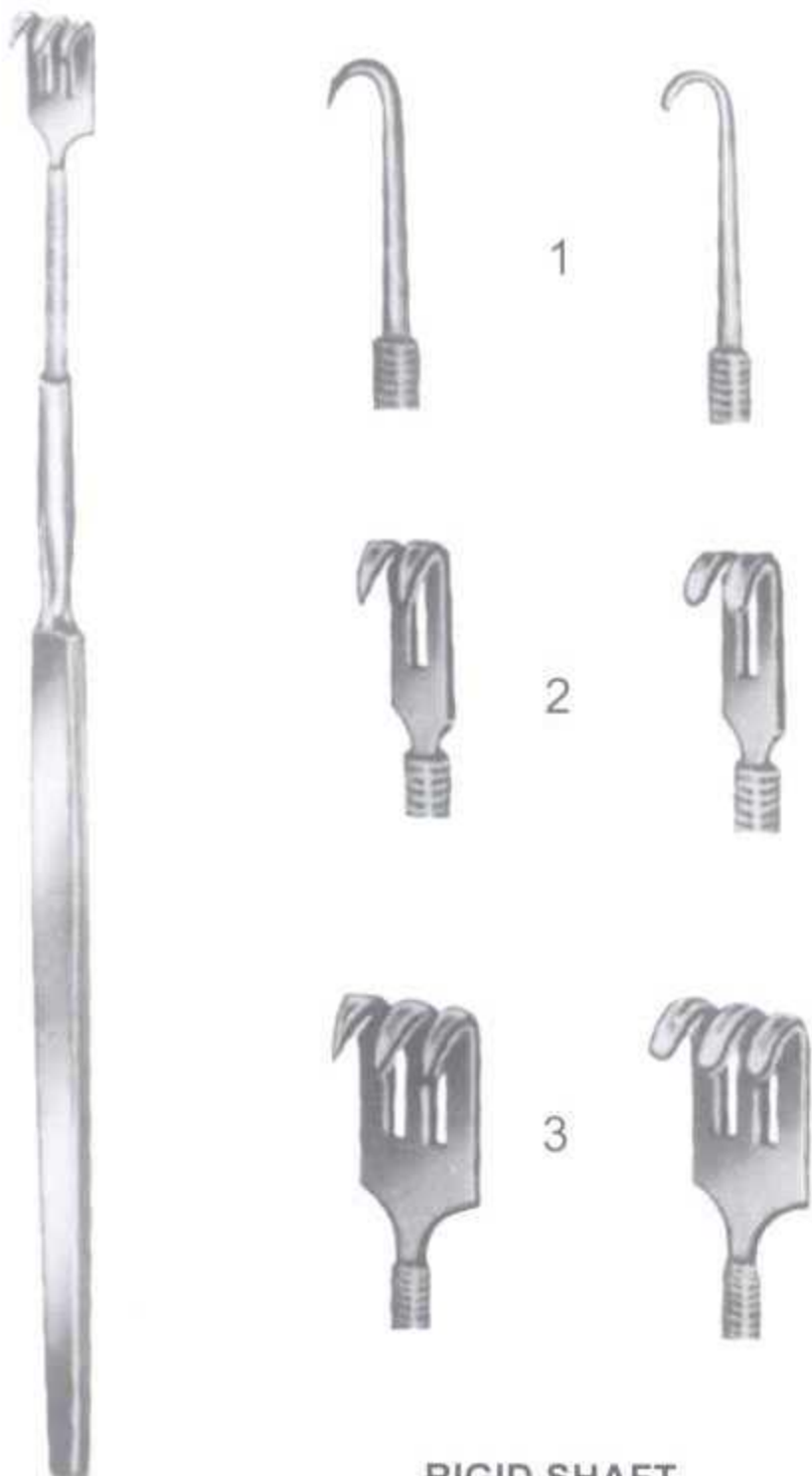

RIGID SHAFT
 NE-322-01 6 1/2" (Fig.1 to 3) Sharp
 NE-323-02 6 1/2" (Fig.1 to 3) Blunt

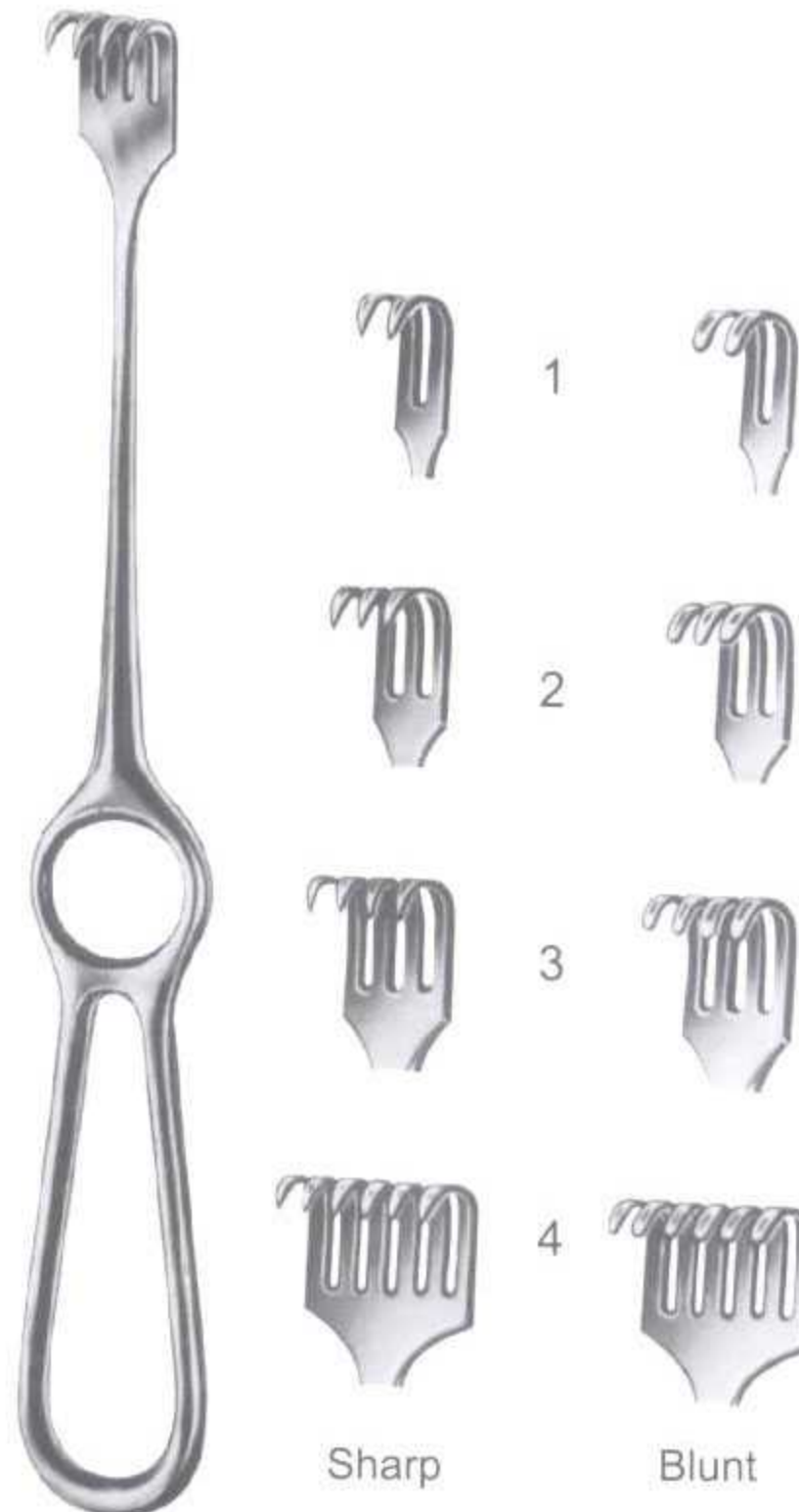

VOLKMAN
 NE-324-01 8 1/2" (Fig.1 to 4) Sharp
 NE-325-02 8 1/2" (Fig.1 to 4) Blunt



RAGNELL
 NE-326-06 6"



PIN WHEELS, SUCTION TUBE & NAIL CUTTERS



WARTENBURG PIN WHEEL
 NE-357-07 7½" C.P
 NE-358-07 7½" S.S



YANKAUER
 NE-359-00



MAGILL
 NE-360-06 6¾"
 NE-360-08 8"
 NE-360-10 10"



NE-361-12 12 cm



NE-362-05 5½"
 NE-363-06 6¼"



NE-364-04 4½"
 NE-365-05 5½"

RETRACTORS



FARABEU (Set of 2)
NE-334-04 4³/₄"
NE-334-03 3"



U.S.ARMY (Set of 2)
NE-335-08 8¹/₂"

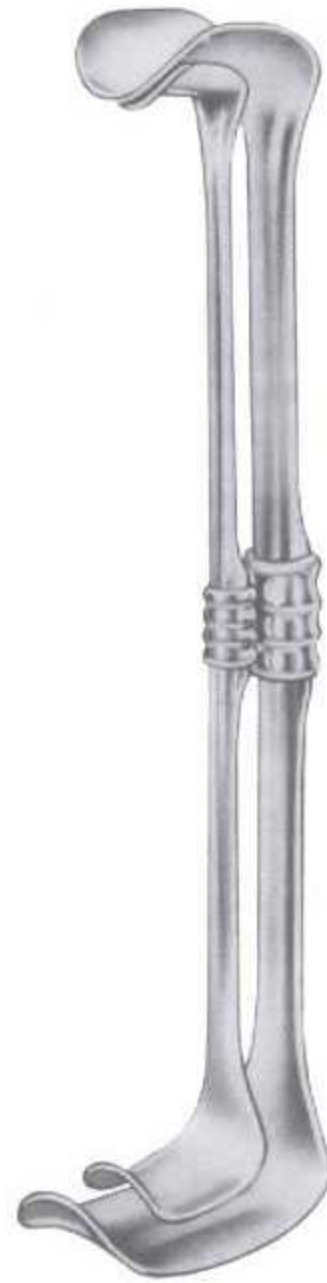

RICHARDSON EASTMAN (Set of 2)
NE-336-11 11"

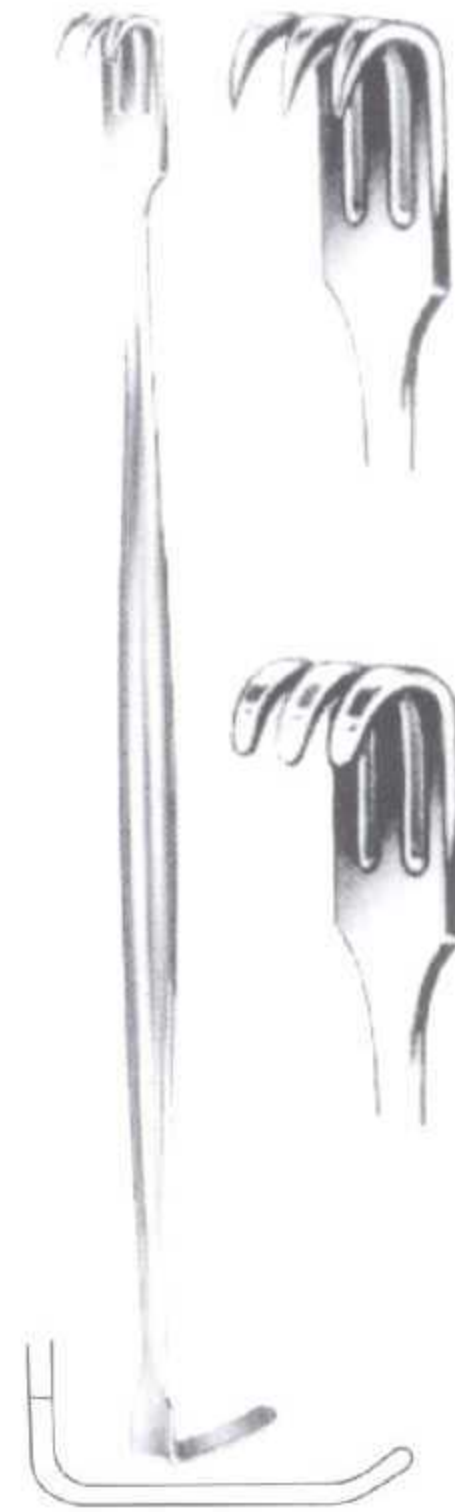

SENN
NE-337-11 11¹/₄" Sharp
NE-337-11 11¹/₄" Blunt



VEIN
NE-338-09 9"



WEITLANER
NE-339-01 5¹/₂" Sharp
NE-339-02 5¹/₂" Blunt
NE-339-03 6¹/₂" Sharp
NE-339-04 6¹/₂" Blunt



JANSEN
NE-340-04 4¹/₂"



GELPI
NE-341-06 6³/₄"

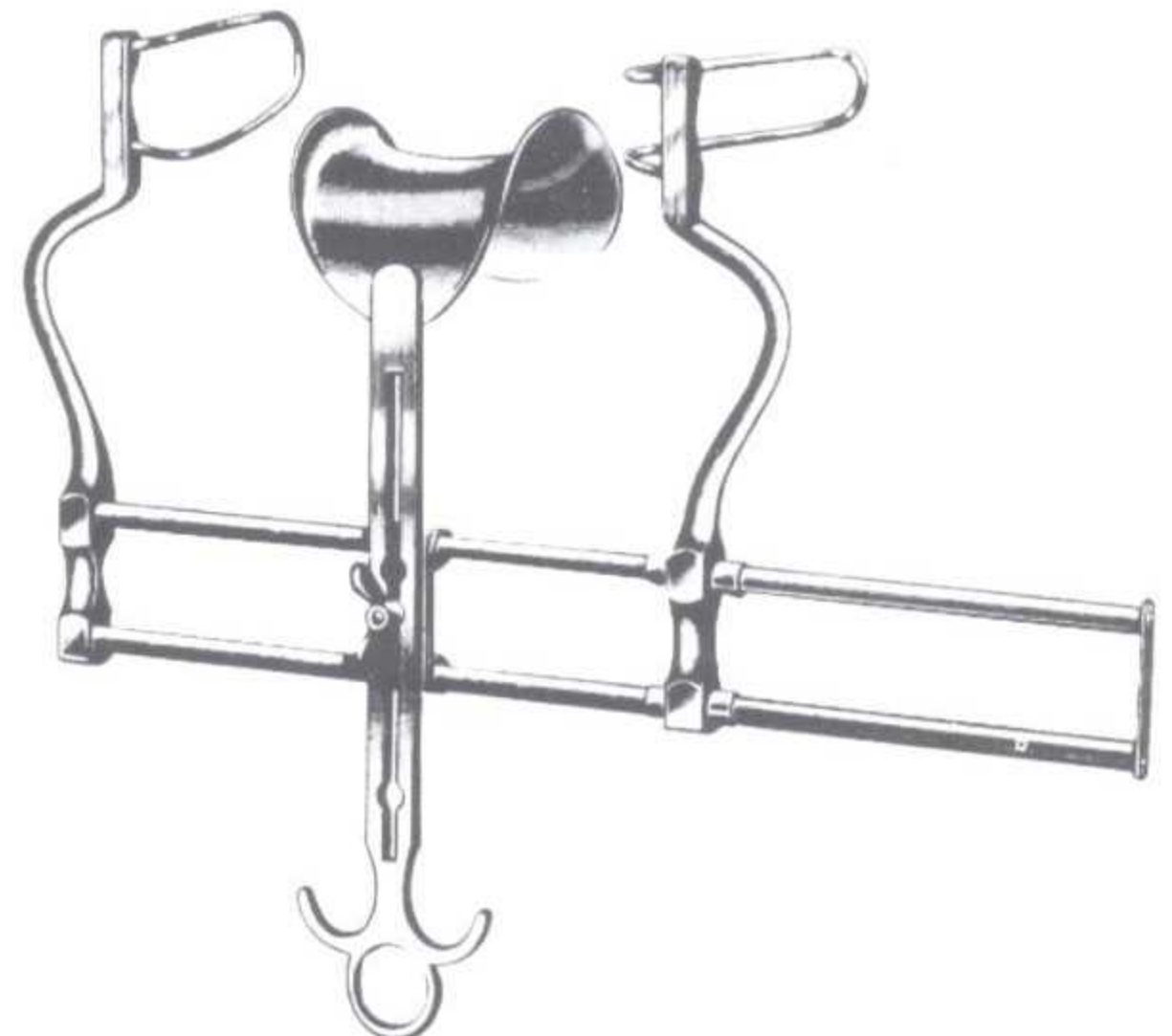

BALFOUR
NE-342-00



GENERAL & OBSTETRICAL

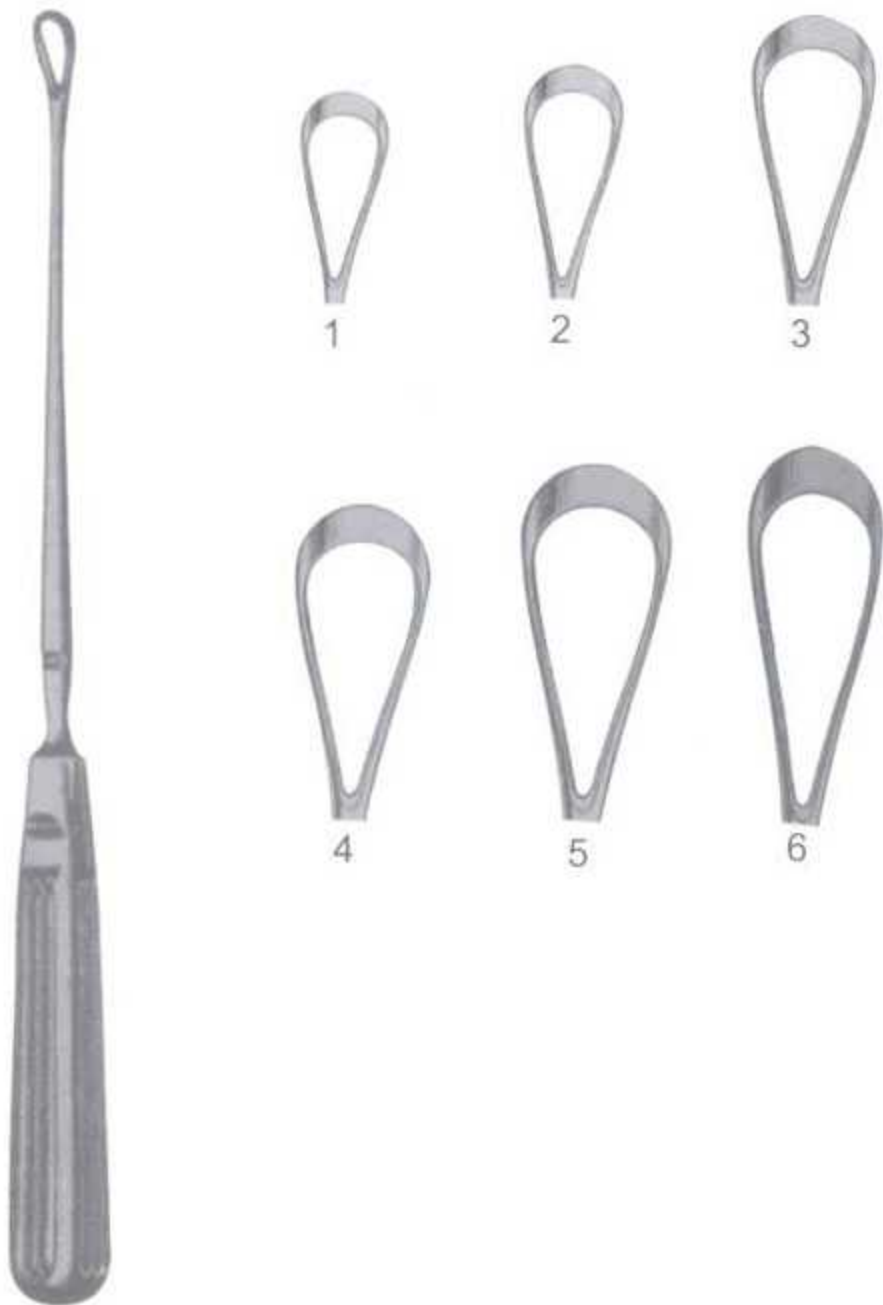

SIMS

- NE-343-11 11" Sharp
- NE-344-11 11" Blunt

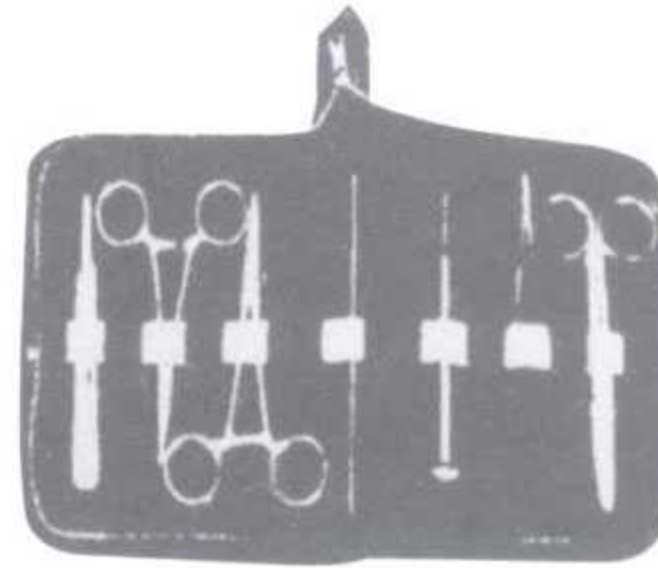

NE-345-01 Set of 7

DISSECTING KITS

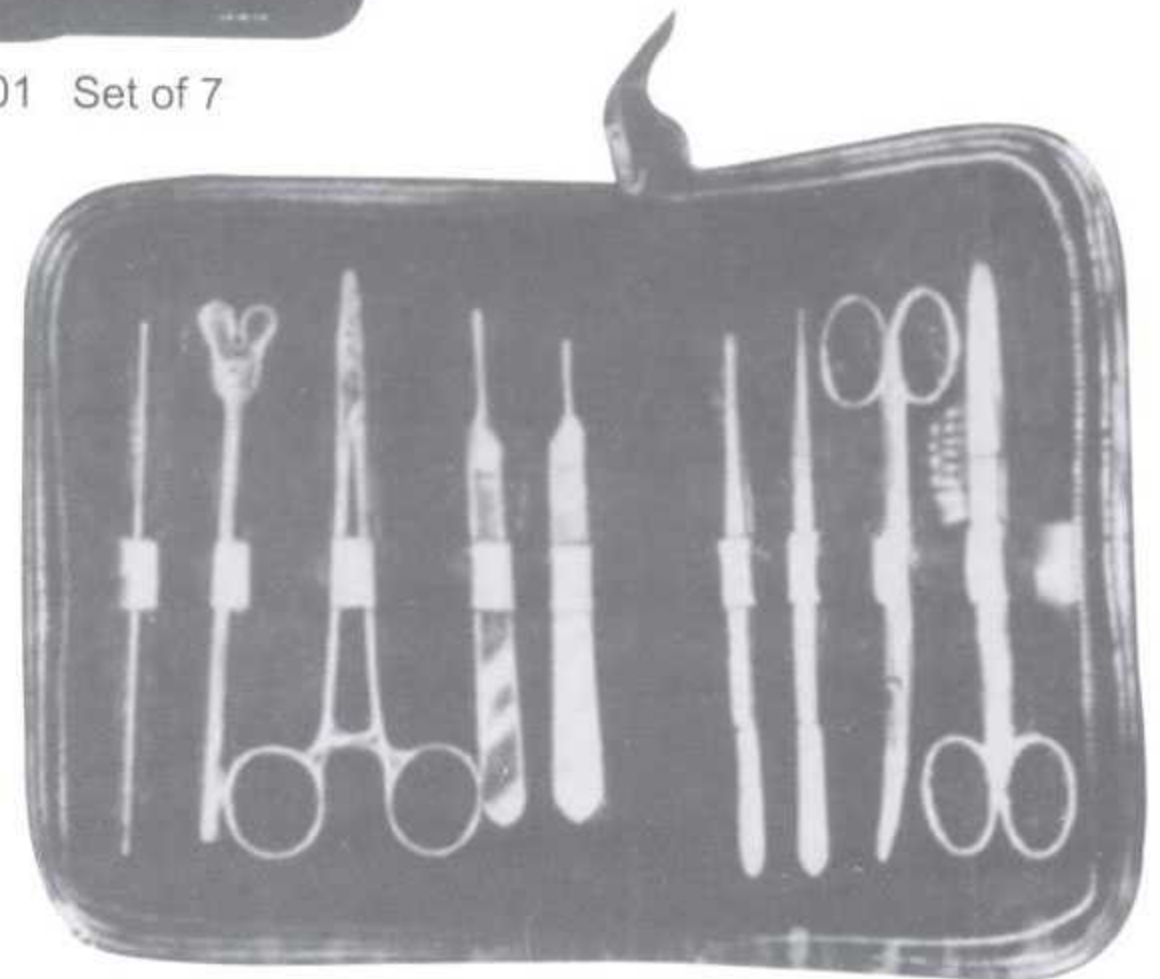

NE-345-02 Set of 9



SIMPSON
NE-346-12 12"
NE-347-14 14"



KIELLAND
NE-348-16 16"



MARTIN
NE-349-13 13 1/2"



BOWLES
NE-350-00



FORD
NE-351-01



FORD - BOWLES
NE-352-02



TAYLOR
NE-353-07 7½"
C.P.



BUCK
NE-354-CP C.P
NE-355-SS S.S



BABINSKY
NE-356-08 8¾"
NE-357-10 10"



RABINER
NE-356-09 9"

TWEEZERS & SNIPPERS



PERRY
NE-365-01

NE-366-01

NE-367-01

SELF-LOCKING
NE-368-01

MERIAM
NE-369-01

COLLEGE
NE-370-01

PAPER
NE-371-01

SOLDERING
NE-372-02 Smooth
NE-373-03 Serrated

SNIPPER
NE-374-04



NE-375-05

NE-376-06

NE-377-07

NE-378-08

NE-379-09

NE-380-00

NE-381-01

NE-382-02

CUTICAL
NE-383-03 3 1/2"
NE-383-03 3 1/2"



SINGLE USE INSTRUMENTS



NE-384-00



NE-385-00



NE-386-00



NE-387-00



NE-388-00



NE-389-00



NE-390-00



NE-391-00



NE-392-00



NE-393-00



NE-394-00



WEBSTER (Large Rings)

- | | |
|----------------------|---------------------|
| NE-395-04 LRS 4 3/4" | NE-396-04 LR 4 3/4" |
| NE-395-05 LRS 5" | NE-396-05 LR 5" |
| NE-395-05 LRS 5 1/2" | NE-396-05 LR 5 1/2" |
| NE-395-06 LRS 6" | NE-396-04 LR 6" |
| NE-395-08 LRS 8" | NE-396-08 LR 8" |

Satin

Mirror Finish



HALSEY (Large Rings)

- | |
|------------------------|
| NE-397-01 LRS 6" Satin |
| NE-397-02 LR 6" Mirror |



MAYO HEGAR (Large Rings)

- | |
|------------------------|
| NE-398-05 5 1/2" Satin |
| NE-398-06 6" Satin |
| NE-398-08 8" Satin |



WEBSTER ULTRA SMOOTH (Large Rings) Special Pattern

- | |
|------------------------|
| NE-399-05 LRS 5" Satin |
| NE-399-06 LRS 6" Satin |



BAUMGARTNER (Large Rings)

- | |
|------------------------|
| NE-400-05 5" Satin |
| NE-400-06 5 1/2" Satin |



OLSEN HEGAR (Large Rings)

- | |
|------------------------|
| NE-401-05 5 1/2" Satin |
|------------------------|



GRADE A LINE



SPONGE HOLDING
NE-402-09 9 1/2" Straight

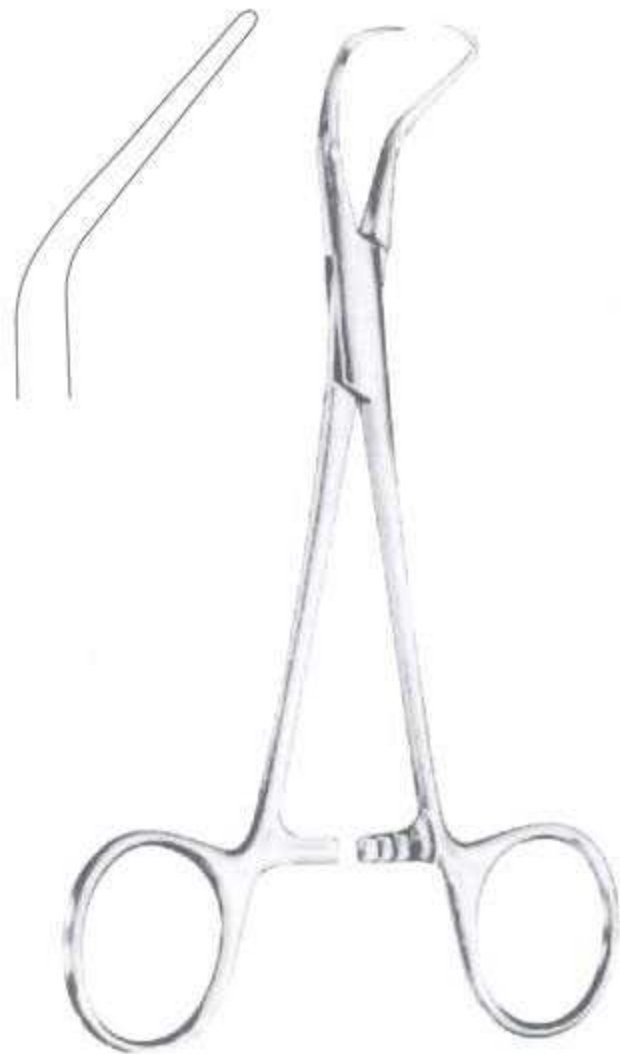

BACKHAUS TOWEL
NE-403-03 3 1/2"



HARTMAN ALLIGATOR
NE-404-03 3 1/2" Straight



DEBAKEY
NE-405-06 6 1/4" Straight



THUMB DRESSING
NE-406-05 5 1/2"



SEMKIN
NE-407-04 4 1/4" (No Pin)



ADSON TISSUE (Wide Pattern)
NE-408-04 4 3/4" 1x2 Teeth
NE-409-04 4 3/4" Serrated



ADSON TISSUE (Fine Point)
NE-410-04 4 3/4" 1x2 Teeth
NE-411-04 4 3/4" Serrated



DUVAL
NE-412-14 5 1/2"



COLLIN-DUVAL
NE-413-20 8"

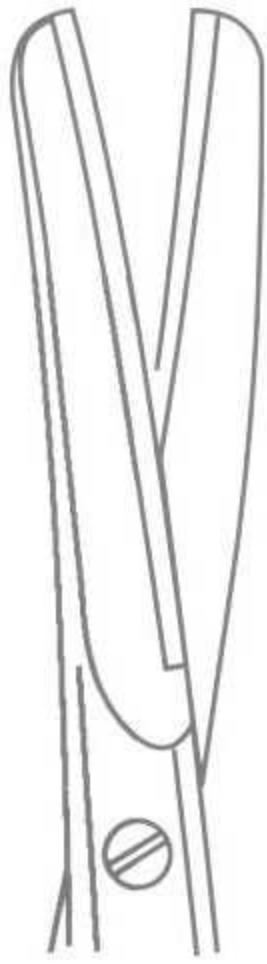
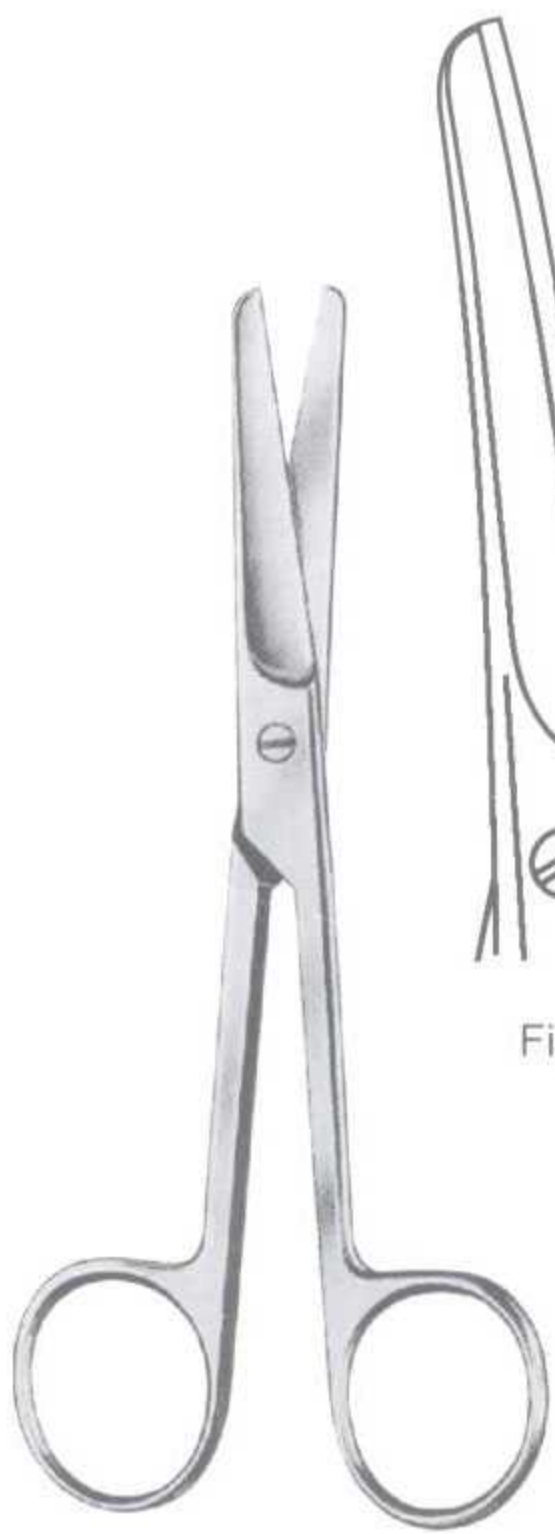

Fig.1



Fig.2

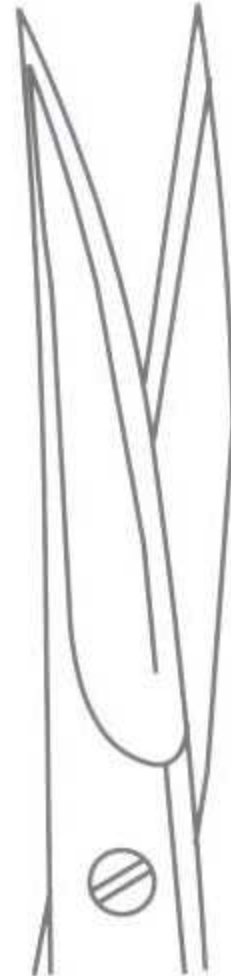

Fig.3

OPERATING

- NE-413-01 4½" Sharp/Blunt
- NE-413-02 5½" Sharp/Blunt
- NE-413-03 5½" Blunt/Blunt



IRIS

- NE-414-01 4½"
- NE-414-02 4½" Large Rings
- NE-415-01 4½"
- NE-415-02 4½" Large Rings



MAYO DISSECTING

- NE-416-06 6¾"
Straight



LITTAUER STITCH

- NE-417-04 4½"
- NE-417-04 4½" Large Rings



LISTER BANDAGE

- NE-418-05 5¾"



BEEBEE

- Straight

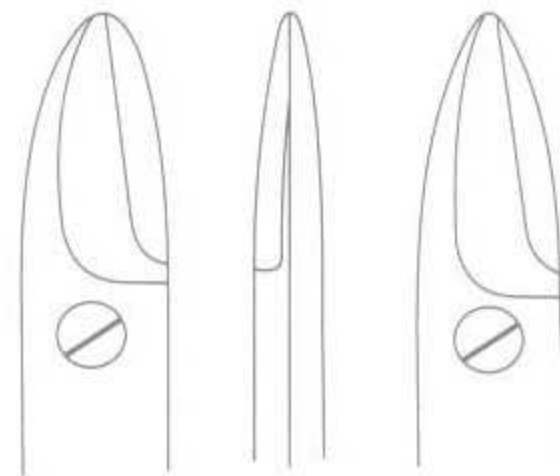

NE-419-04 4¼" Blunt NE-420-04 4¼" Pointed



Saw Edge

WIR CUTTING (Angled)

- NE-421-04 4¾"



GRADE A LINE



HALSTEAD MOSQUITO
NE-422-01 5"
NE-422-02 5" Large Rings
NE-423-01 5"
NE-423-02 5" Large Rings



HALSTEAD MOSQUITO
Fine Point
NE-424-05 5"
NE-425-05 5"



KELLY HAMOSTATIC
NE-426-05 5½"
NE-427-05 5½"



CRILE RANKIN
NE-428-06 6¼"
Curved



ROCHESTER PEAN
NE-429-08 8"
Curved



ALLIS TISSUE
NE-430-06 86"
4X5 Teeth



GRAVES VAGINAL SPECULUM

- NE-431-0S Small
- NE-432-0M Medium
- NE-433-0L Large



PEDERSON VAGINAL SPECULUM

- NE-434-0S Small
- NE-435-0M Medium
- NE-436-0L Large



PROBE WITH EYE
NE-437-05 5½"

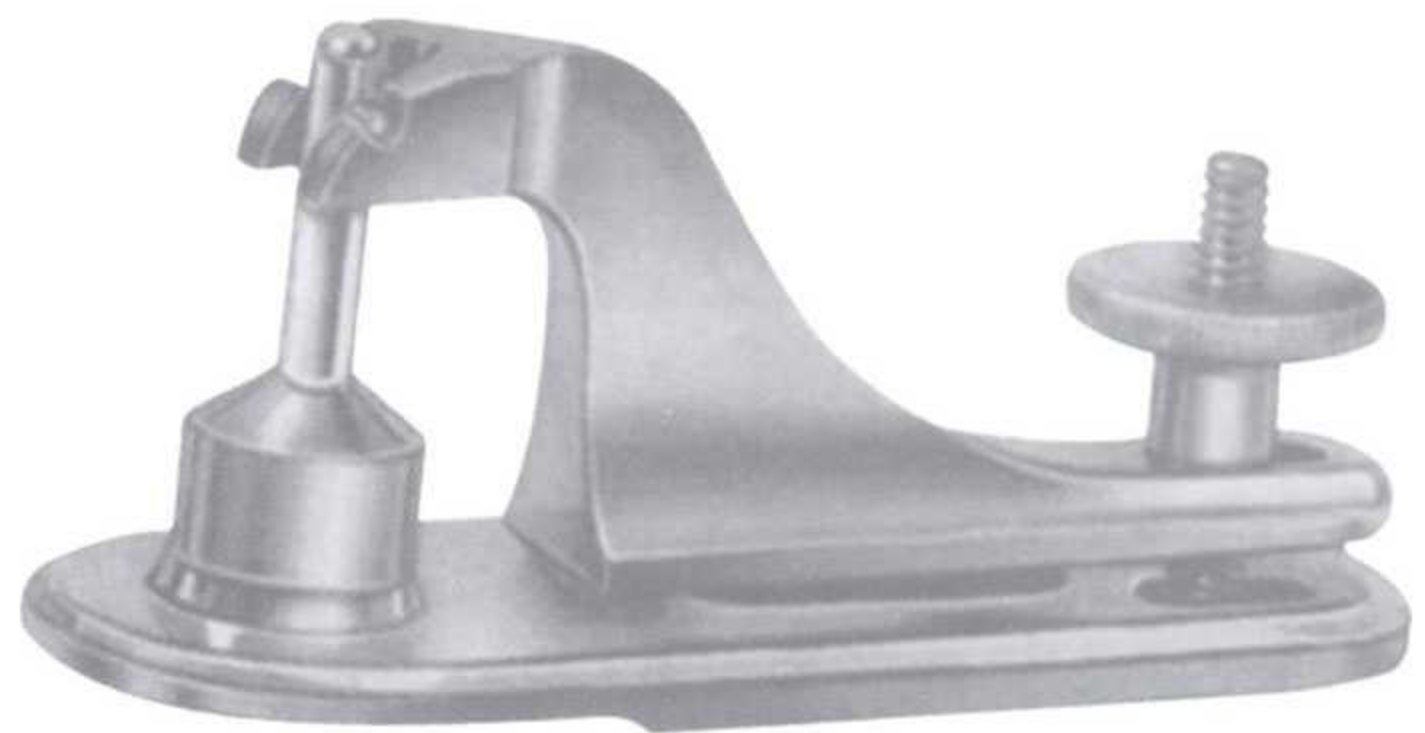

GUMCO CLAMP
NE-437-07 1.1 cm
NE-437-08 1.3 cm
NE-437-45 1.45 cm



EXTRACTING FORCEPS (American Pattern)



NE-501-W1
Fig. W1 winter



NE-502-01
Fig. 1



NE-503-02
Fig. 2



NE-503-04
Fig. 4



NE-504-05
Fig. 5

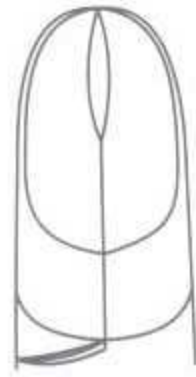

NE-505-06
Fig. 6

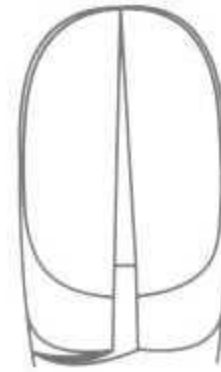

NE-506-07
Fig. 7

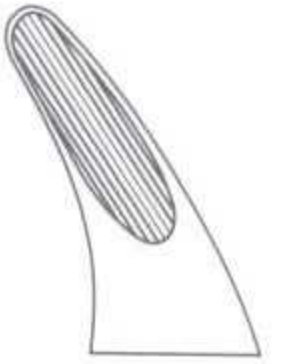

EXTRACTING FORCEPS (American Pattern)



NE-507-08
Fig. 8



NE-508-10H
Fig. 10H



NE-509-10S
Fig. 10S

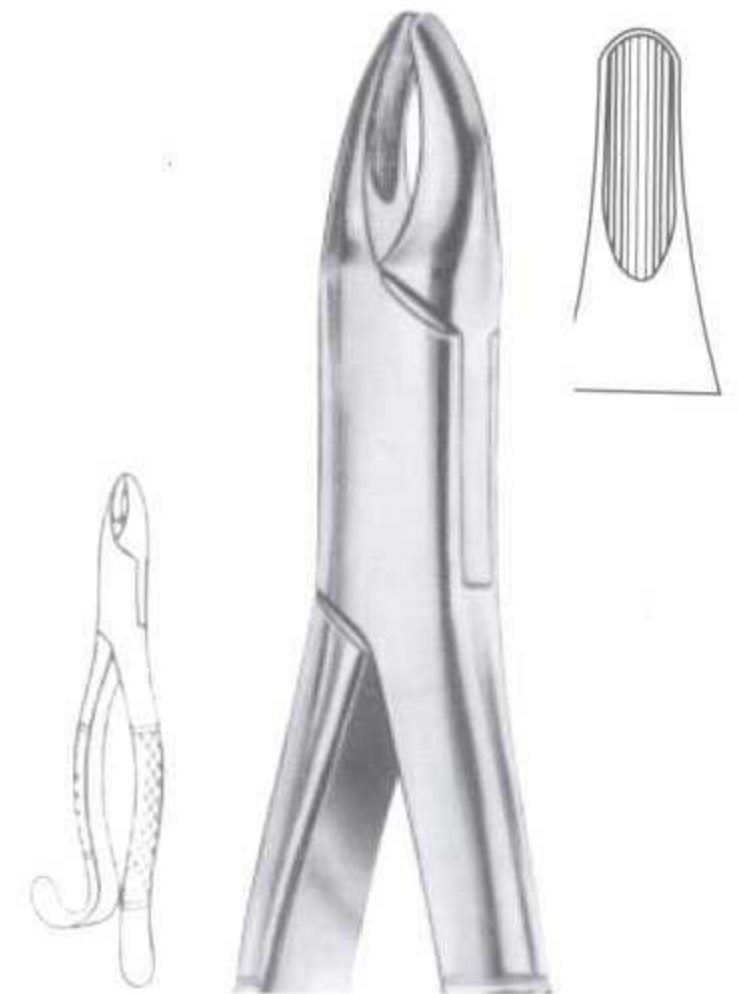

NE-510-13
Fig. 13



NE-513-16
Fig. 16



NE-511-16S
Fig. 16S

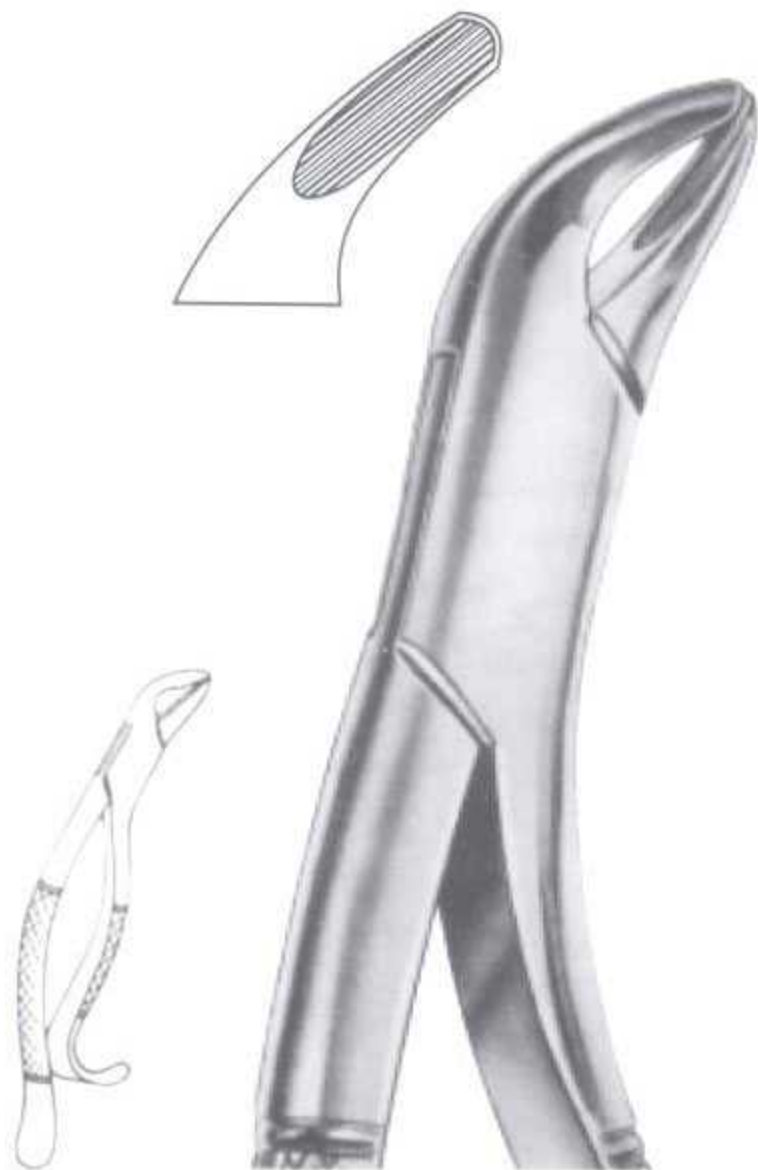

NE-512-14
Fig. 14



NE-514-17
Fig. 17

EXTRACTING FORCEPS (American Pattern)

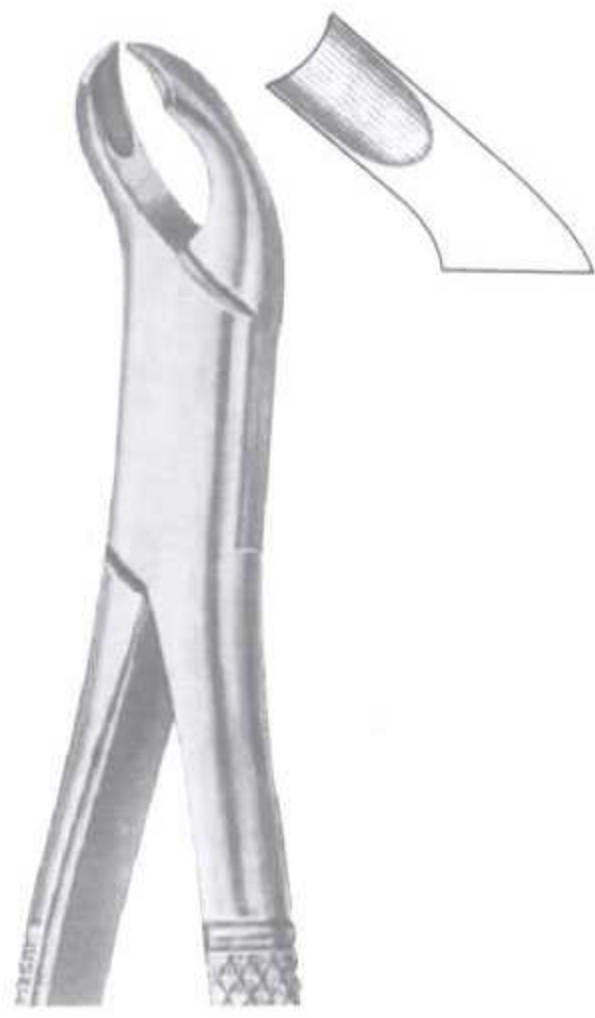

NE-522-90
Fig. 90

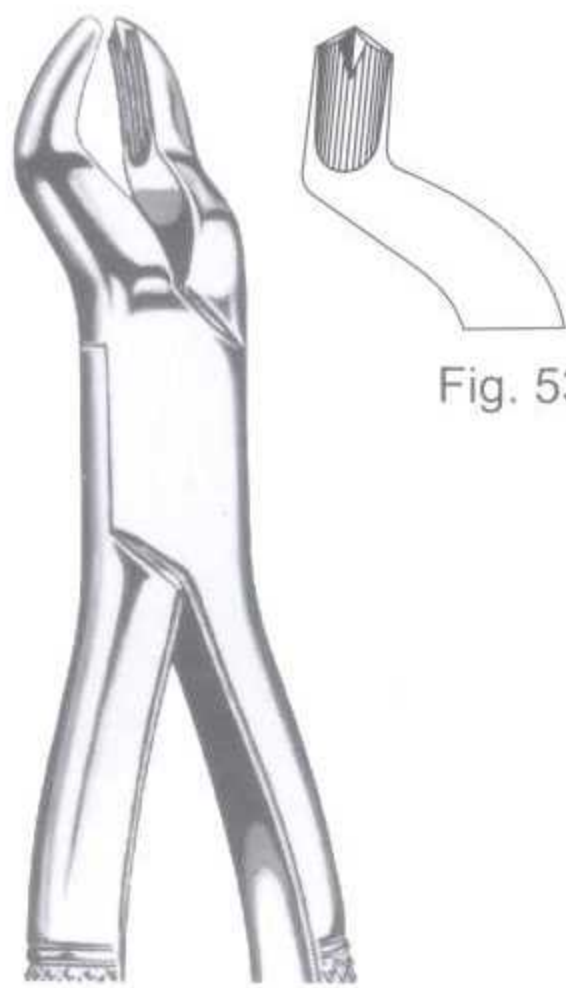

NE-523-01
Fig.53L

Fig. 53L

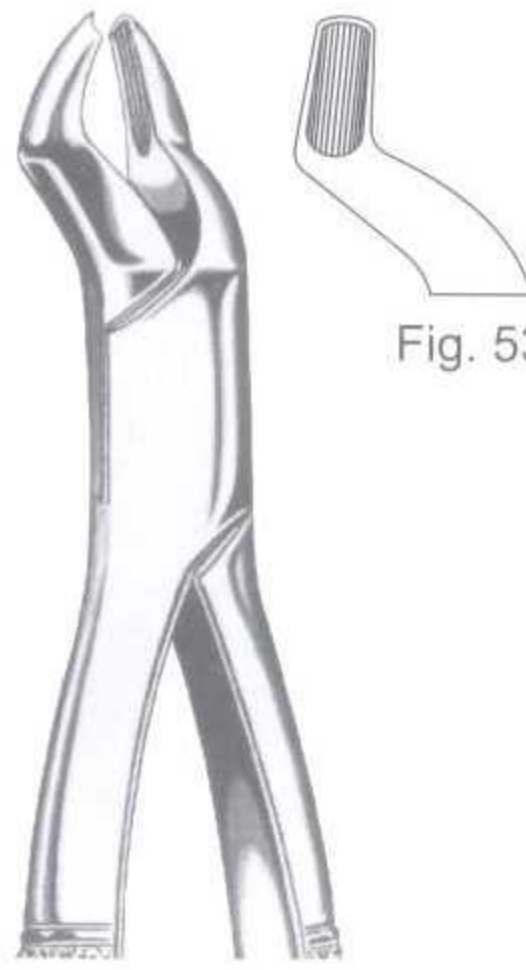

NE-523-02
Fig.53R

Fig. 53R

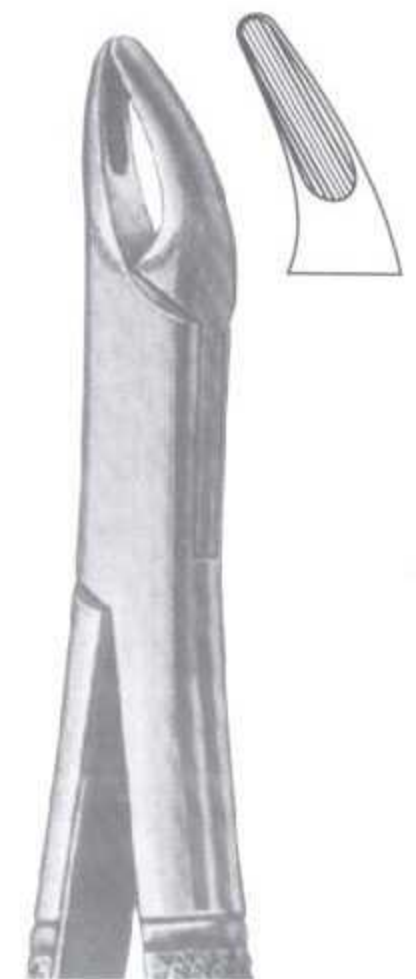

NE-524-150
Fig.150



Fig. 151
CRYER

NE-525-151
Fig.151

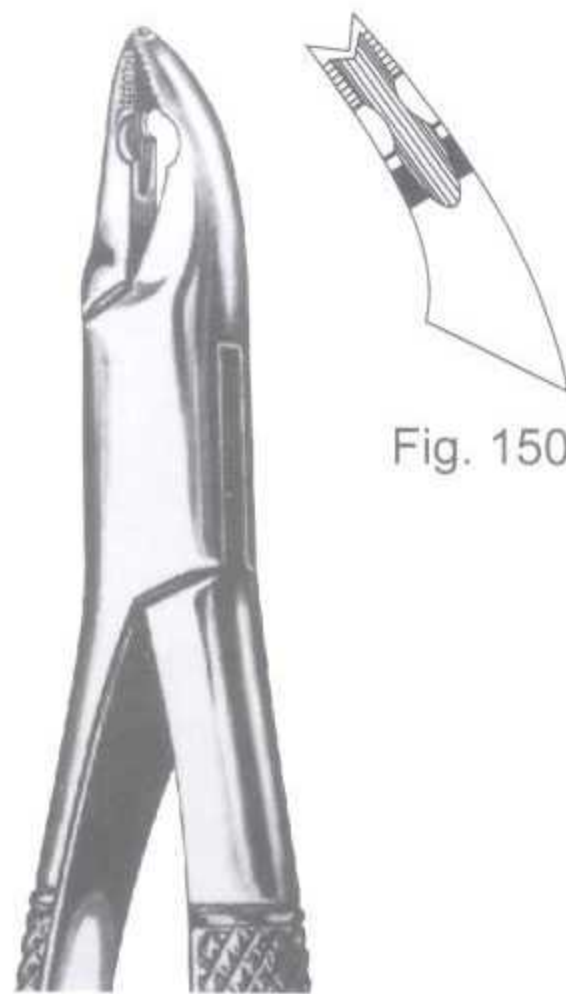

Fig. 150AS

NE-526-150
Fig.150AS



Fig. 151AS

NE-527-151
Fig.151AS

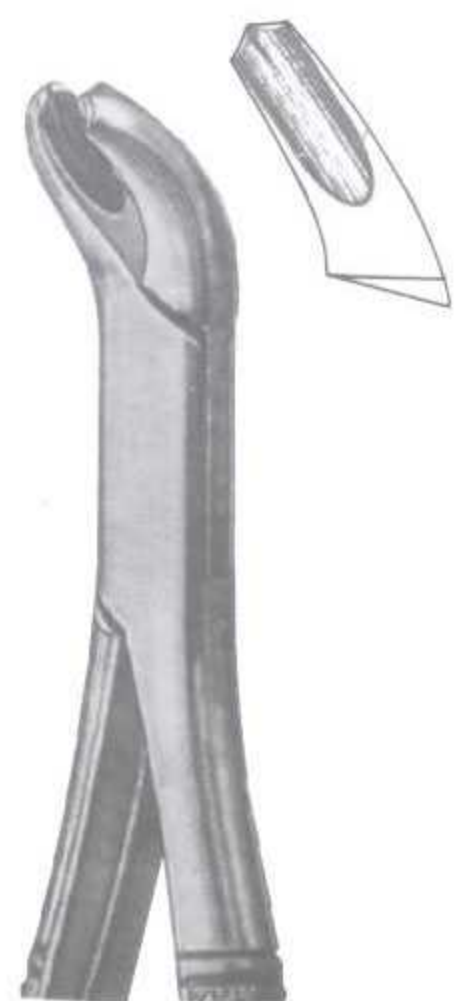

NE-528-17
Fig.17S



NE-529-23
Fig.23S



Fig. 150S
CRYER

NE-530-150
Fig.150S



Fig. 151S
CRYER

NE-531-151
Fig.151S

EXTRACTING FORCEPS (English Pattern)



NE-545-01
MEAD

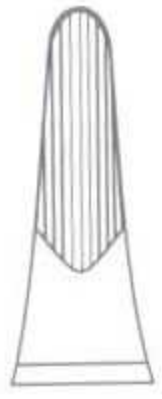

Fig .MD1



NE-545-02
MEAD



Fig .Md2

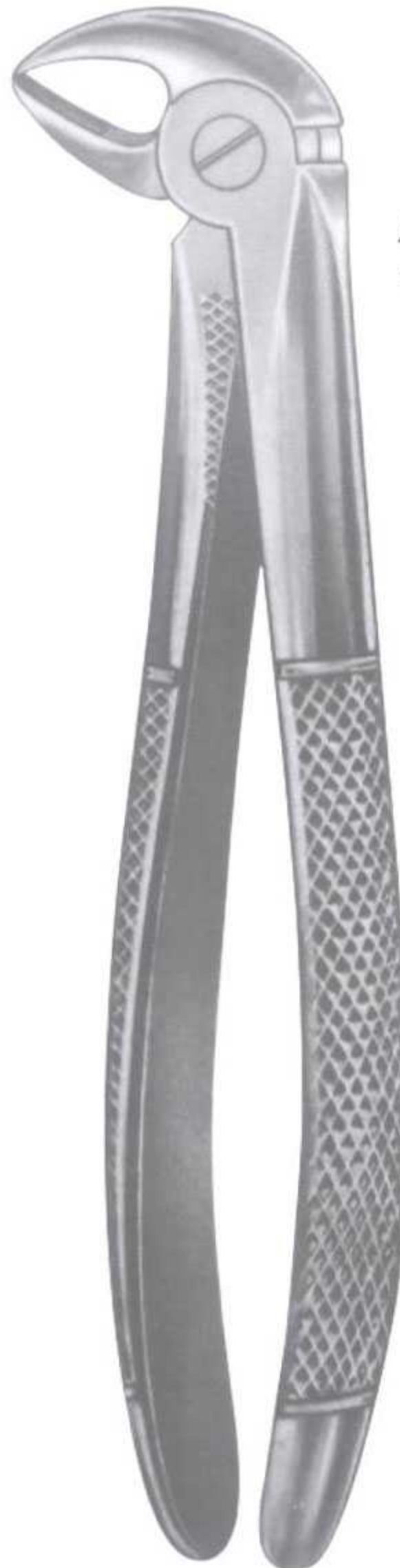

NE-545-03
MEAD



Fig .Md3



NE-545-04
MEAD

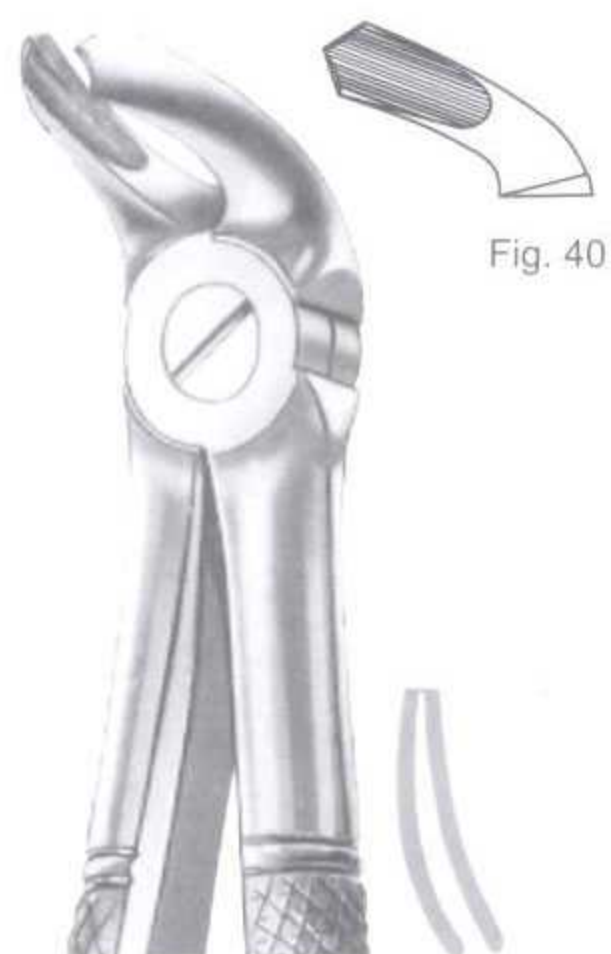

Fig .Md4



EXTRACTING FORCEPS (English Pattern)

Extracting Forceps For Children



NE-546-40
Fig. 40

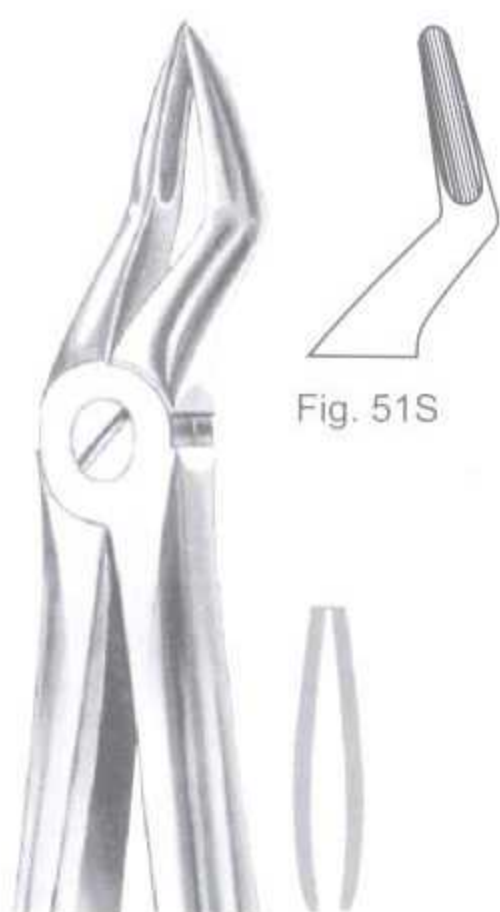

NE-547-51
Fig. 51S

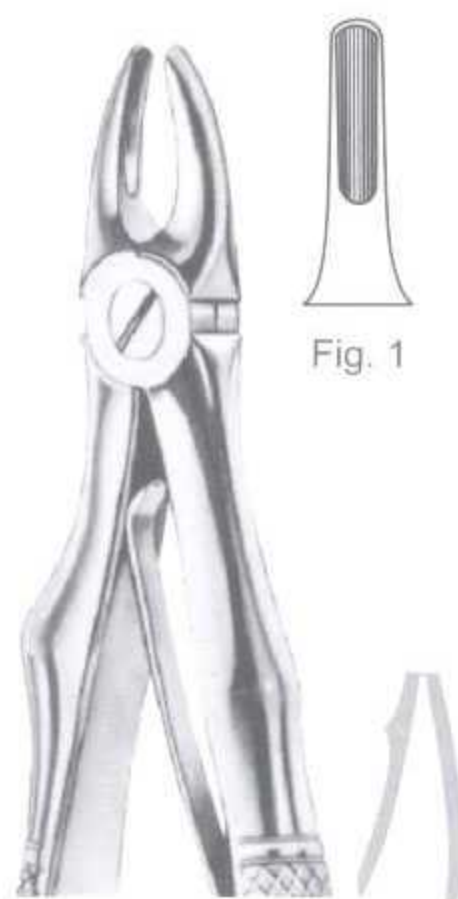

NE-548-01
Fig. 1



NE-549-02
Fig. 2

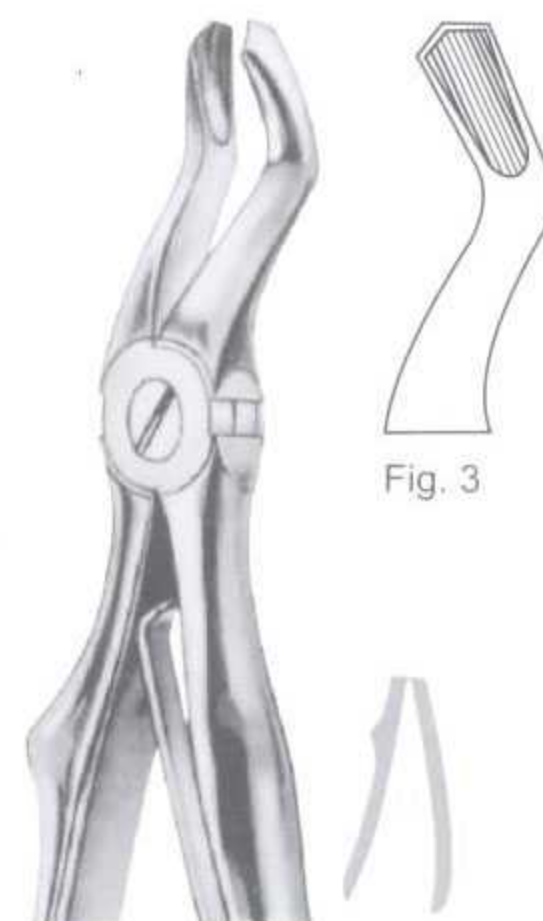

NE-550-03
Fig. 3



NE-551-04
Fig. 4



NE-552-05
Fig. 5



NE-553-06
Fig. 6

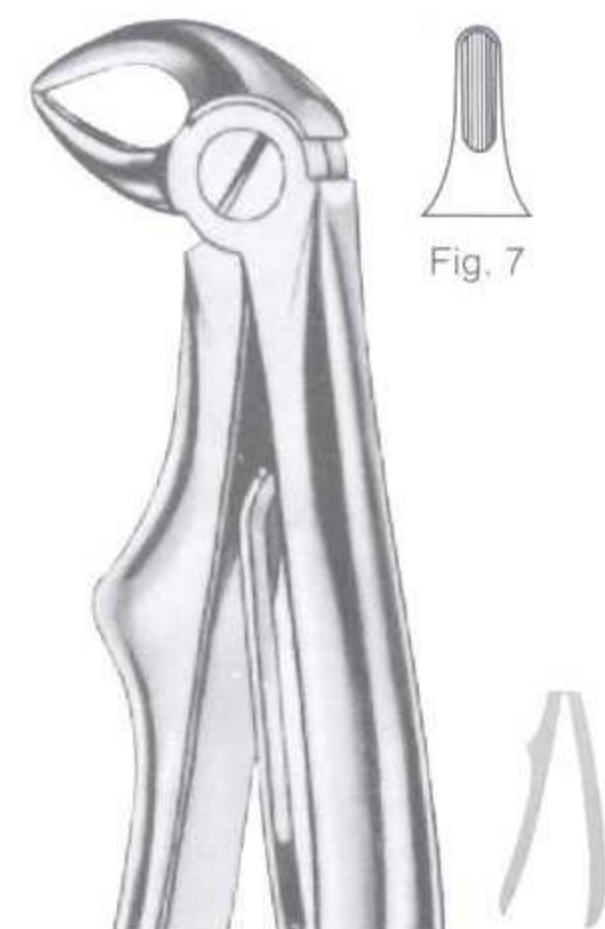

NE-554-07
Fig. 7

ROOT ELEVATORS



NE-555-00
SELDIN



NE-555-01
Fig.1L
Seldin



NE-555-02
Fig.1R
Seldin



NE-555-03
Fig. 2
Seldin



NE-555-03
Fig. 3
Seldin



NE-556-03
Fig. 3A
Cryer



NE-555-04
Fig.4L
Seldin



NE-555-04
Fig.4R
Seldin



NE-557-01
Fig. 301
APICAL STANDARD



NE-557-02
Fig. 302
Apical Standtard



NE-557-03
Fig. 303
Apical Standtard



NE-557-04
Fig. 304
Apical Standtard



NE-558-01
Fig. L
Coleman
London Hospital



NE-558-02
Fig. R
Coleman
London Hospital



ROOT ELEVATORS

| 2 mm |



NE-559-01
Fig.1
BEIN

| 3 mm |



NE-559-02
Fig.2
Bein

| 4 mm |



NE-559-03
Fig.3
Bein

| 2 mm |



NE-559-04
Fig.4
Bein

| 3 mm |



NE-559-05
Fig.5
Bein

| 4 mm |



NE-559-06
Fig.6
Bein

| 3 mm |



NE-559-07
Fig.7
Bein

| 4 mm |



NE-559-08
Fig.8
Bein

| 5.0 mm |



NE-560-01
Fig.1
BEIN

| 4.0 mm |



NE-560-02
Fig.2
Bein

| 3.5 mm |



NE-560-03
Fig.3
Bein

ROOT ELEVATORS



1.8 mm



NE-561-01
Fig. 1
HEIDBRINK

1.8 mm



NE-561-02
Fig. 2
Heidbrink

NE-561-03
Fig. 3
Heidbrink



HEIDBRINK



NE-562-12
1.2 mm
Heidbrink



NE-562-15
1.5 mm
Heidbrink



NE-562-12
1.2 mm
Heidbrink



NE-562-15
1.5 mm
Heidbrink



NE-562-18
1.8 mm
Heidbrink



NE-562-25
2.5 mm
Heidbrink



MIRRORS & HANDLES



3
20 mm Ø

4
22 mm Ø

5
24 mm Ø



4
22 mm Ø

5
24 mm Ø

PLANE

- NE-564-01 3=20 mm
- NE-564-02 4=22 mm
- NE-564-03 5=24 mm

MAGNIFY

- NE-565-04 4=20 mm
- NE-565-05 5=22 mm



HILGER
NE-563-18
Holder with
welded-on handle
18 cm



NE-566-01
Hollow Stainless



NE-566-03
Hollow Stainless



NE-566-04
Solid Stainless



NE-566-05
Hollow Stainless

SYRINGES



Auto Self Aspirating
(dual action) syringe
NE-567-01 , 1.8 ml
NE-567-02 , 2.2ml



Standard cartridge syringe
NE-568-01 , 1.8 ml
NE-568-02 , 2.2ml



Standard syringe
NE-569-01 , 1.8 ml
NE-569-02 , 2.2ml



Two ring aspirating syringe
NE-570-01 , 1.8 ml
NE-570-02 , 2.2ml



Tri-ring aspirating syringe
NE-571-01 , 1.8 ml
NE-571-02 , 2.2ml



Ring type european aspirating syringe
NE-572-01 , 1.8 ml
NE-572-02 , 2.2ml



A type auto self
aspirating
(dual action) syringe
NE-573-01 , 1.8 ml
NE-573-02 , 2.2ml



adoption for all
patterns, short



adoption for all
patterns, long



Single ring aspirating syringe
NE-574-01 , 1.8 ml
NE-574-02 , 2.2ml



NE-575-01
Pistol type intraligamental syringe
mirror finish
1.8 ml



NE-576-01
Pistol type intraligamental syringe
black handle
1.8 ml



NE-577-01
Skyp-ject
Miniature intraligamental syringe 1.8ml



NE-578-01
Skyp-ject
Miniature intraligamental syringe 1.8ml



AMALGAM CARRIERS



NE-580-01
DISTAL

NE-579-01
SINGLE-END

NE-580-01
DOUBLE-END



1.5 mm

2.0 mm

NE-581-01
Mini-Regular



2.8 mm

2.0 mm

NE-581-02
Grande-Regular



3.2 mm

2.0 mm

NE-581-03
Jumbo-Regular



NE-581-04
Mini-Distal

NE-581-05
Regular-Distal

NE-581-06
Grande-Distal

NE-581-07
SINGLE-END

NE-581-08
Regular
SINGLE-END

NE-581-09
Grande
SINGLE-END

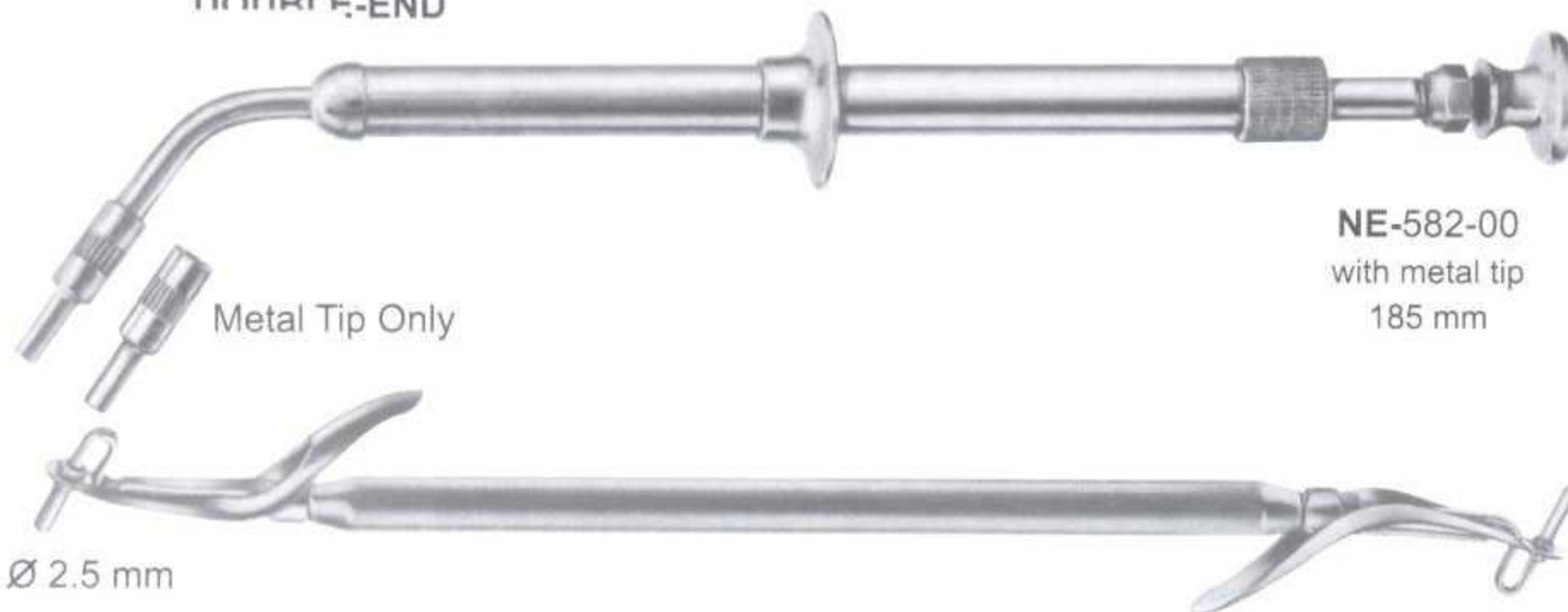

Metal Tip Only

Ø 2.5 mm

NE-582-00
with metal tip
185 mm

NE-583-00
IVORY
210 mm



NE-584-35
Amalgam Wells
Ø 3.5 cm
h 2.5 cm



NE-585-25
Amalgam Wells
Ø 2 cm
h 2.5 cm



NE-586-02
Amalgam Wells
Ø 2 cm
h 4 cm



NE-587-01
with metal tip
135 mm

NE-588-01
with metal tip
145 mm

SCISSORS



NE-589-11
IRIS
11 cm



NE-590-11
11 cm



NE-591-11
11 cm



NE-592-11
11 cm



NE-593-11
11 cm

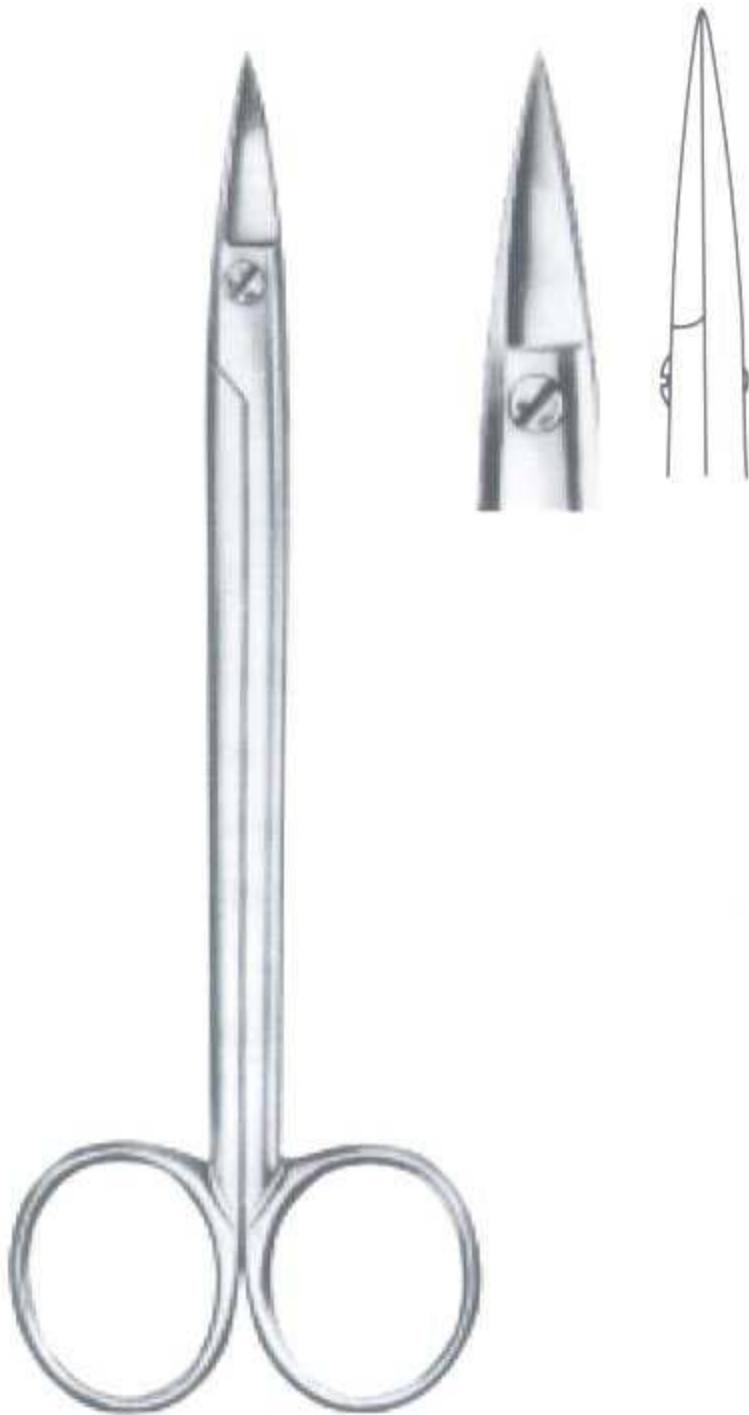

NE-594-12
QUINBY
12.5 cm



NE-595-12
QUINBY
12.5 cm



NE-596-12
NEUMANN
12 cm



COTTON AND DRESSING PLIER



serrated

NE-597-01
15 cm
LONDON-COLLEGE



smooth

NE-597-02
15 cm
LONDON-COLLEGE

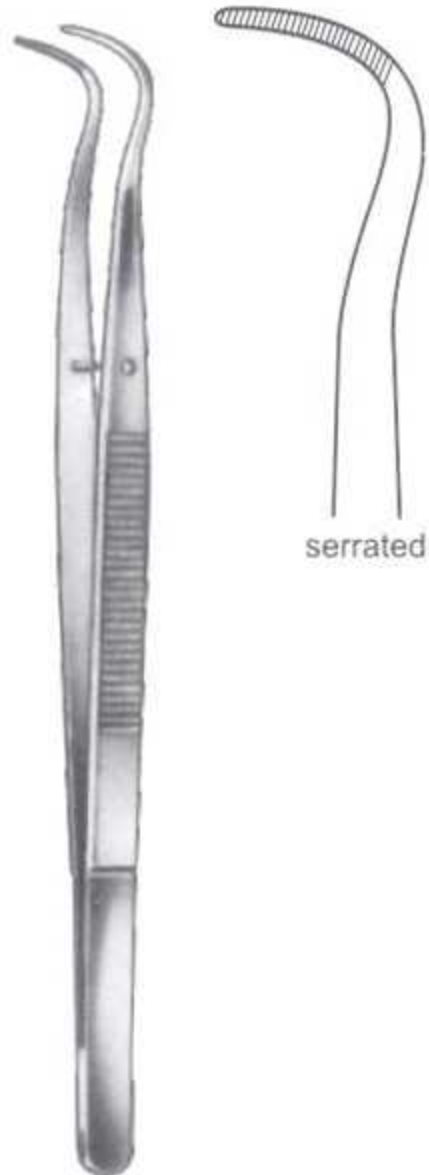

serrated

NE-597-03
15 cm
LONDON-COLLEGE



serrated

NE-597-04
15 cm
LONDON-COLLEGE



smooth

NE-597-05
15 cm
LONDON-COLLEGE

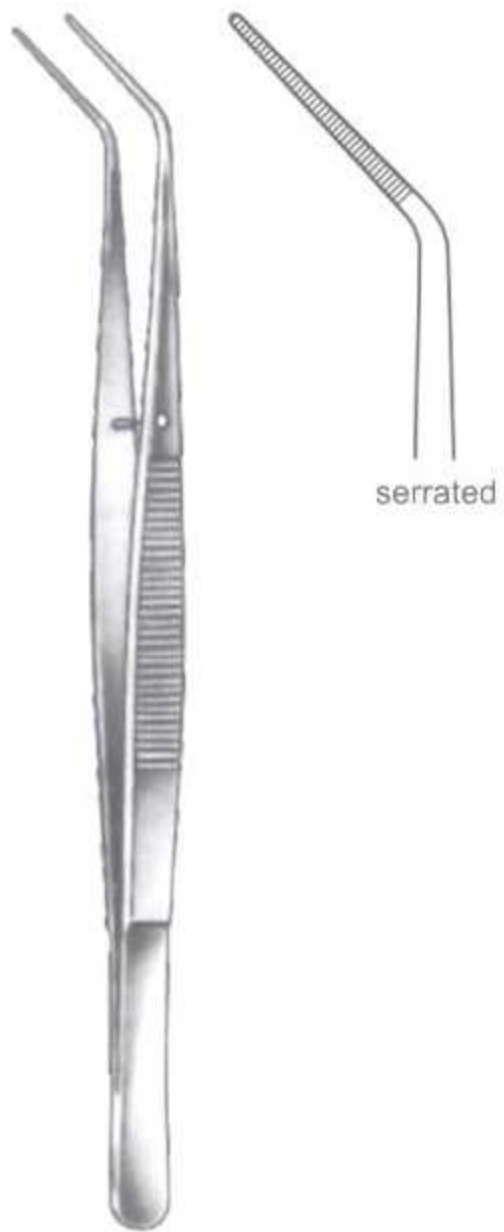

serrated

NE-597-06
15 cm
LONDON-COLLEGE



smooth

NE-597-07
15 cm
LONDON-COLLEGE



serrated

NE-597-08
15 cm
LONDON-COLLEGE



NE-598-01
15 cm
LONDON-COLLEGE
with lock



NE-598-02
15 cm
LONDON-COLLEGE
with lock



NE-598-03
15 cm
LONDON-COLLEGE
with lock

BONE CURETTES



NE-599-00
HOLLOW
LIGHT

NE-600-01
HEMINGWAY
Fig. 1

NE-600-02
HEMINGWAY
Fig. 2

NE-600-03
HEMINGWAY
Fig. 3

NE-600-04
HEMINGWAY
Fig. 4

NE-601-01
LUCAS
Fig. 1

NE-601-02
LUCAS
Fig. 2

NE-601-03
LUCAS
Fig. 3

NE-601-04
LUCAS
Fig. 4



LIP AND CHEEK RETRACTORS

TONGUE DEPRESSORS

Complete Set



STERNBERG
 NE-602-12, 12 cm
 NE-602-14, 14 cm
 NE-602-16, 16 cm



NE-603-00



NE-604-00
HEISTER
 with two screws



MOUTH GAGS & MATRIX RETAINERS



NE-605-14
MOLT
 14 cm



NE-606-12
DENHARD
 12 cm



NE-607-16
ROSER KOENIG
 16 cm



NE-608-01
IVORY
 Fig. 1



NE-609-05
 1 m
 5 mm



NE-610-08
IVORY
 Fig. 8
 5 mm



NE-611-00
TOFFLEMIRE



**NE-612-17
PALMER**
17 cm

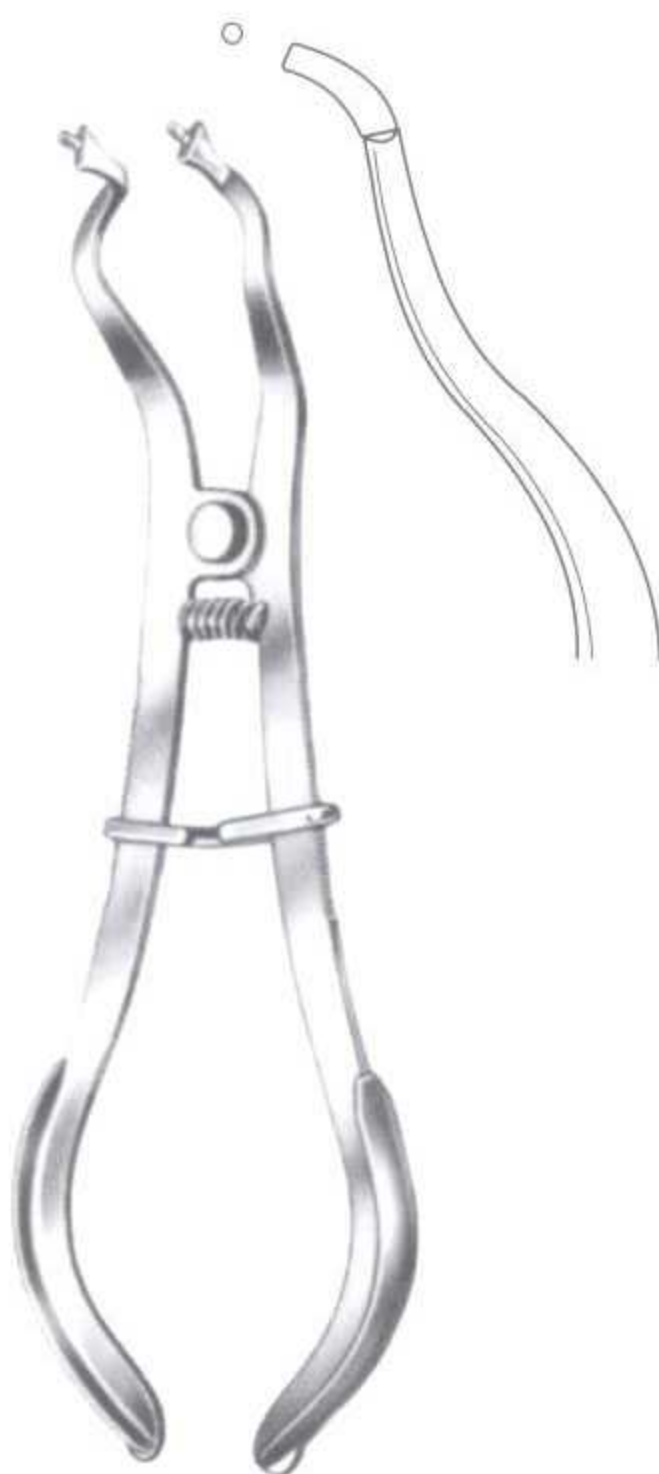

**NE-613-17
BREWER**
17 cm



**NE-615-16
IVORY**
16 cm

NE-614-00



**NE-616-03
CROWN REMOVER**
Complete with 3 Points



**NE-616-04
CROWN REMOVER**
Complete with 3 Points



NE-617-00
Crown Spreader, Crown Remover,
Special instrument for crown spreading
after separating, simple and safe operation



**NE-618-00
CROWN REMOVER**
Complete with 3 points



CURETTES

GRACEY CURETTES



NE-619-01
Fig. 1/2



NE-619-02
Fig. 3/4



NE-619-03
Fig. 5/6



NE-619-04
Fig. 7/8



NE-619-05
Fig. 9/10



NE-619-06
Fig. 11/12



NE-619-07
Fig. 13/14

SCALERS



NE-620-01
Fig. 1
Mc CALL



NE-620-05
Fig. 5
Mc CALL



NE-620-06
Fig. 6
Mc CALL



NE-620-07
Fig. 7
Mc CALL



NE-620-08
Fig. 8
Mc CALL



NE-620-09
Fig. 9
Mc CALL



NE-620-10
Fig. 10
Mc CALL

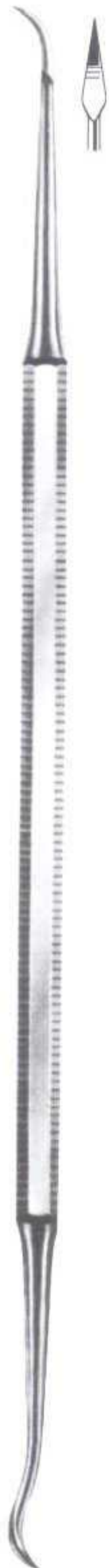

NE-622-01
Fig. 1
CUMINE



NE-621-01
Fig. 1
ABBOTT



NE-621-02
Fig. 2
ABBOTT



NE-621-03
Fig. 3
ABBOTT



NE-621-04
Fig. 4
ABBOTT



NE-623-01
Fig. 1
MITCHELL



NE-624-01
Fig. 1
GUENTHER

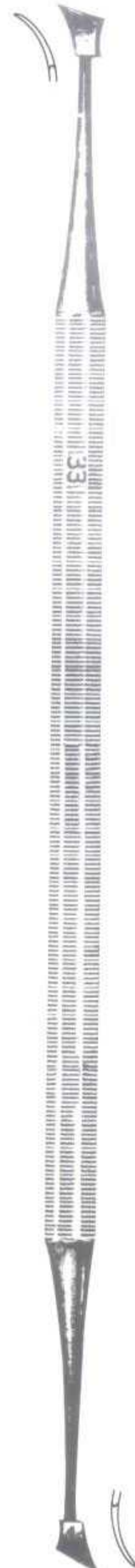

NE-625-33/34
Fig. 33/34



EXCAVATORS

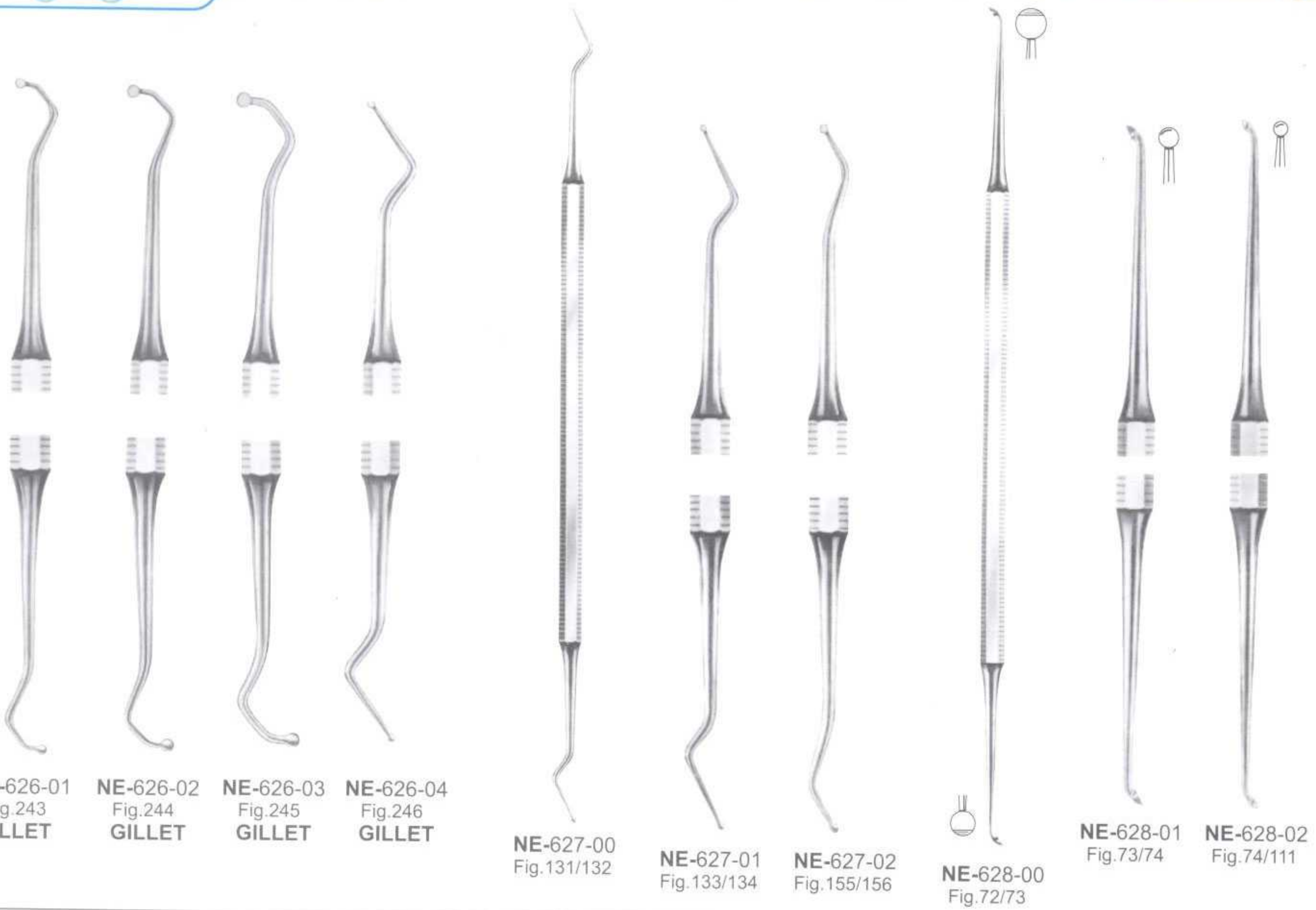

NE-626-01 Fig.243
GILLET

NE-626-02 Fig.244
GILLET

NE-626-03 Fig.245
GILLET

NE-626-04 Fig.246
GILLET

NE-627-00
Fig.131/132

NE-627-01
Fig.133/134

NE-627-02
Fig.155/156

NE-628-00
Fig.72/73

NE-628-01
Fig.73/74

NE-628-02
Fig.74/111

FILLING INSTRUMENTS

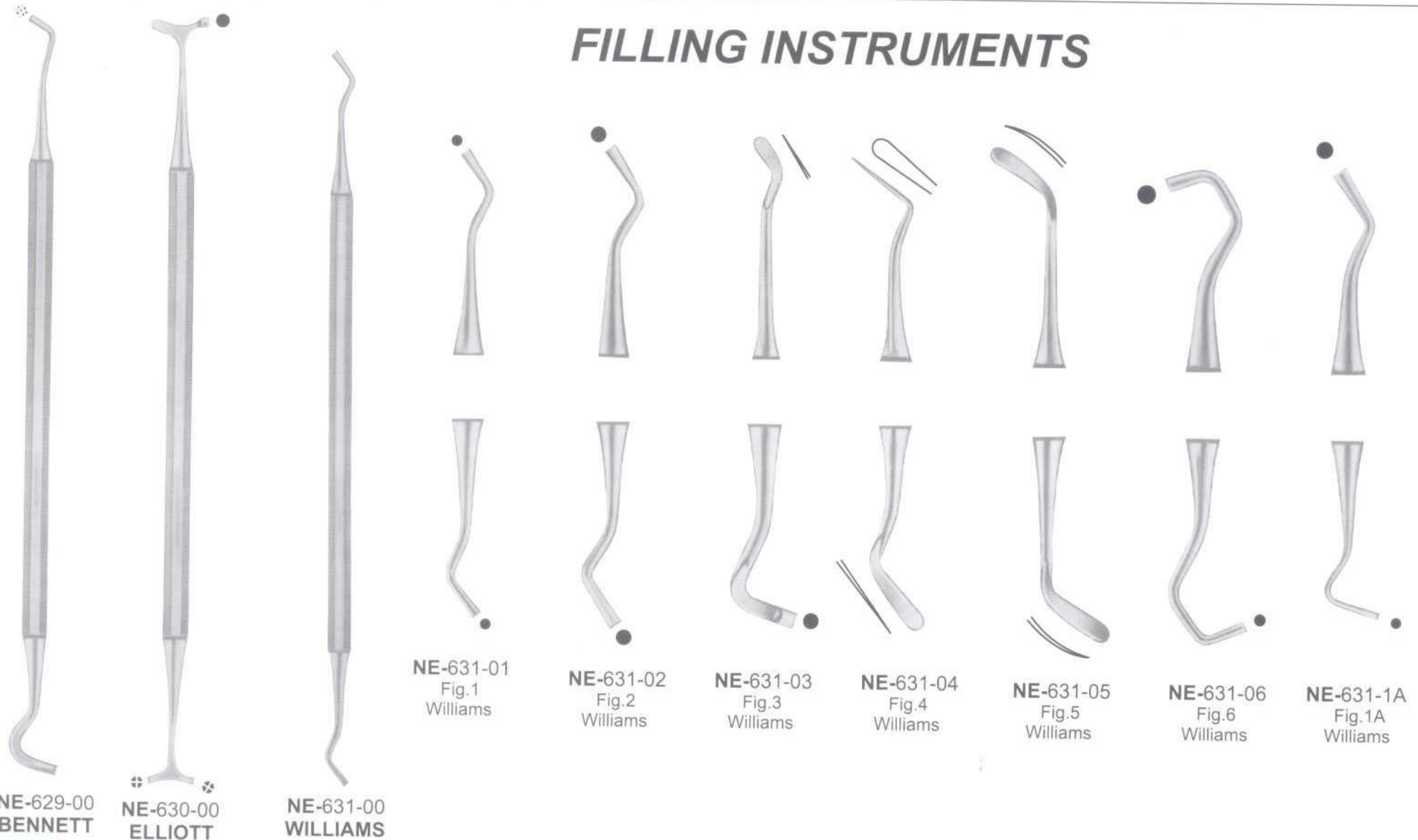

NE-631-01
Fig.1
Williams

NE-631-02
Fig.2
Williams

NE-631-03
Fig.3
Williams

NE-631-04
Fig.4
Williams

NE-631-05
Fig.5
Williams

NE-631-06
Fig.6
Williams

NE-631-1A
Fig.1A
Williams

NE-629-00
BENNETT

NE-630-00
ELLIOTT

NE-631-00
WILLIAMS

BONE RONGEURS



NE-632-15
BLUMENTHAL
15.5 cm

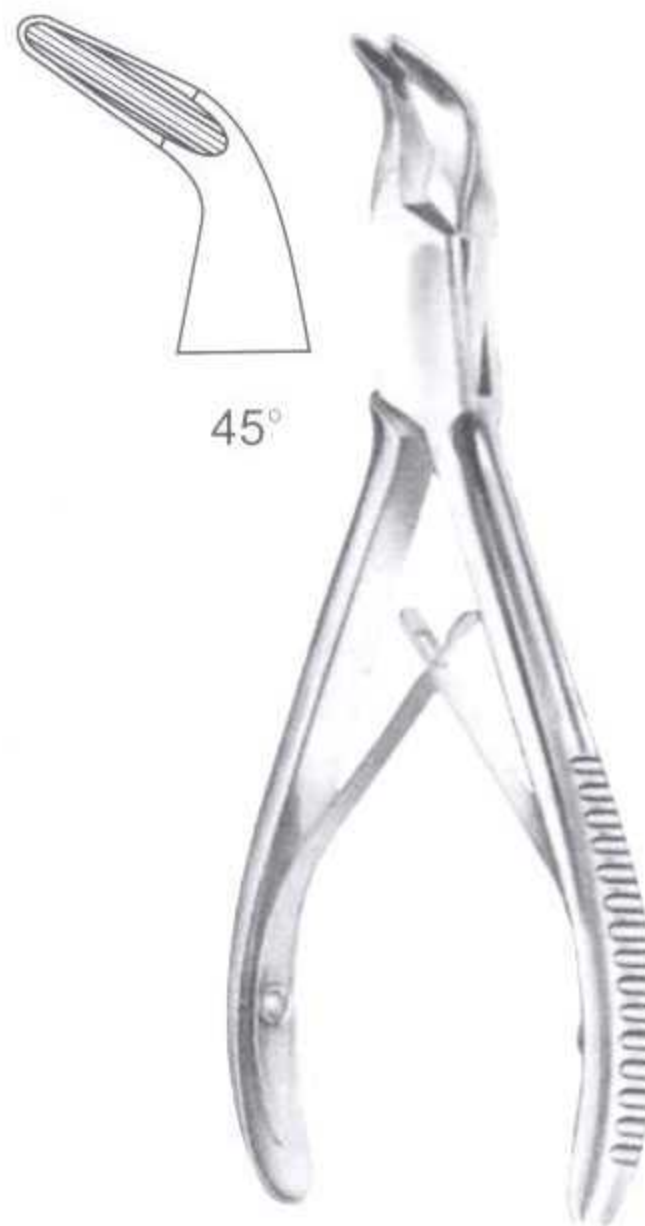

NE-633-15
BLUMENTHAL
15.5 cm

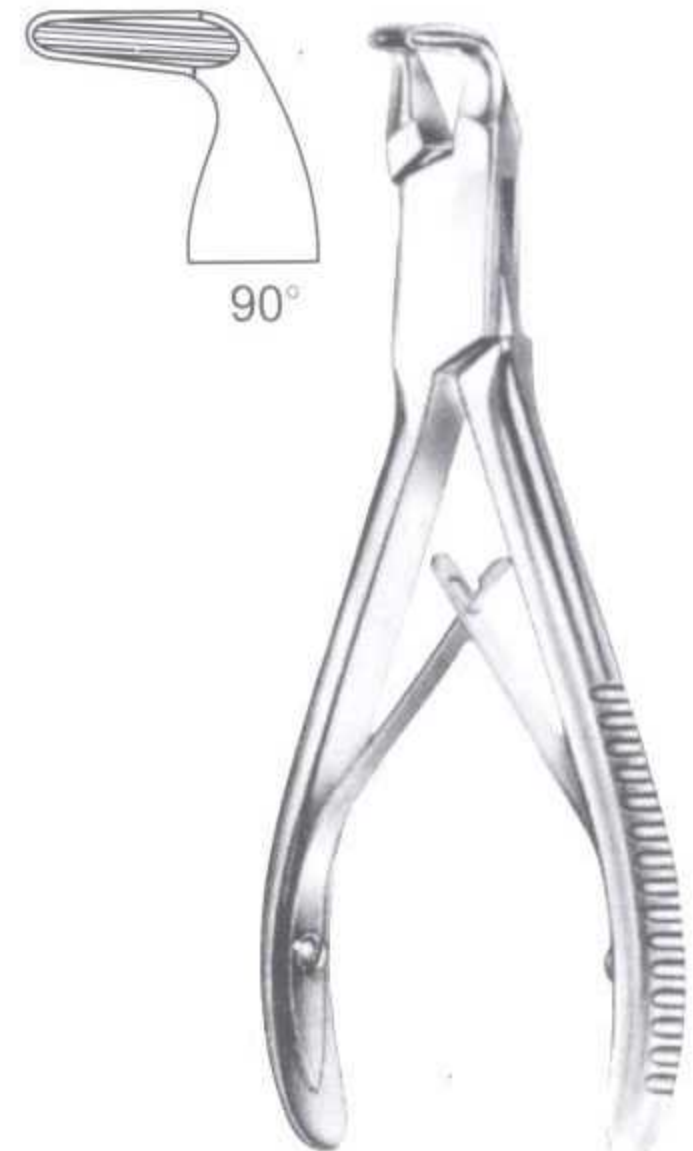

NE-634-15
BLUMENTHAL
15.5 cm

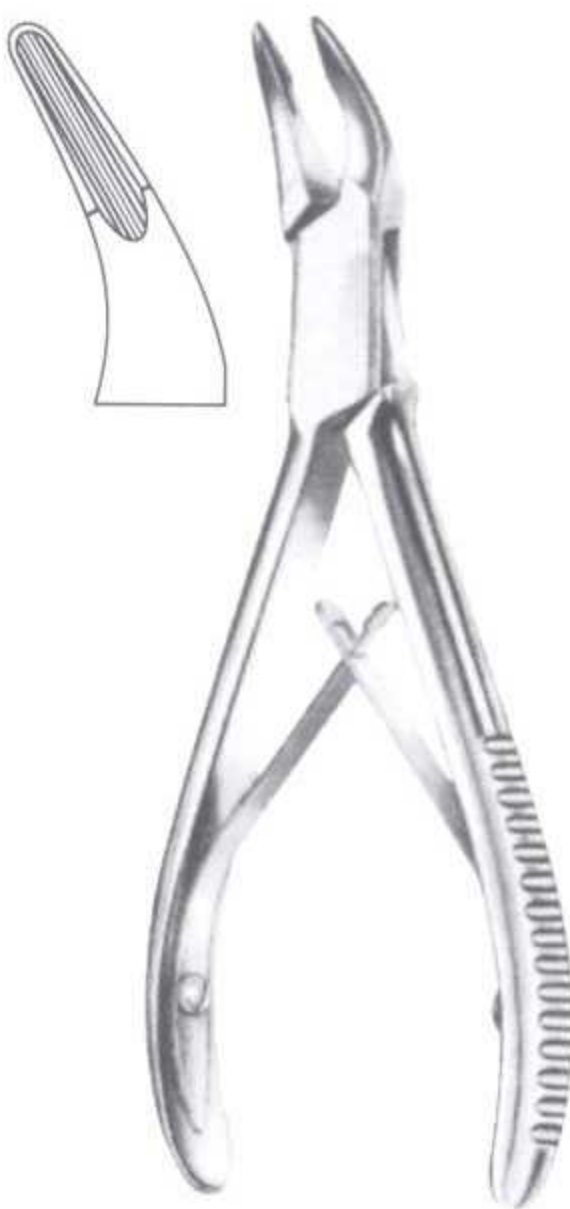

NE-635-0S
BLUMENTHAL-S



NE-636-18
BLUMENTHAL
18 cm



NE-637-00
HARTMANN



ORTHODONTIC PLIERS



NE-637-01
SCHWARZ
13 cm

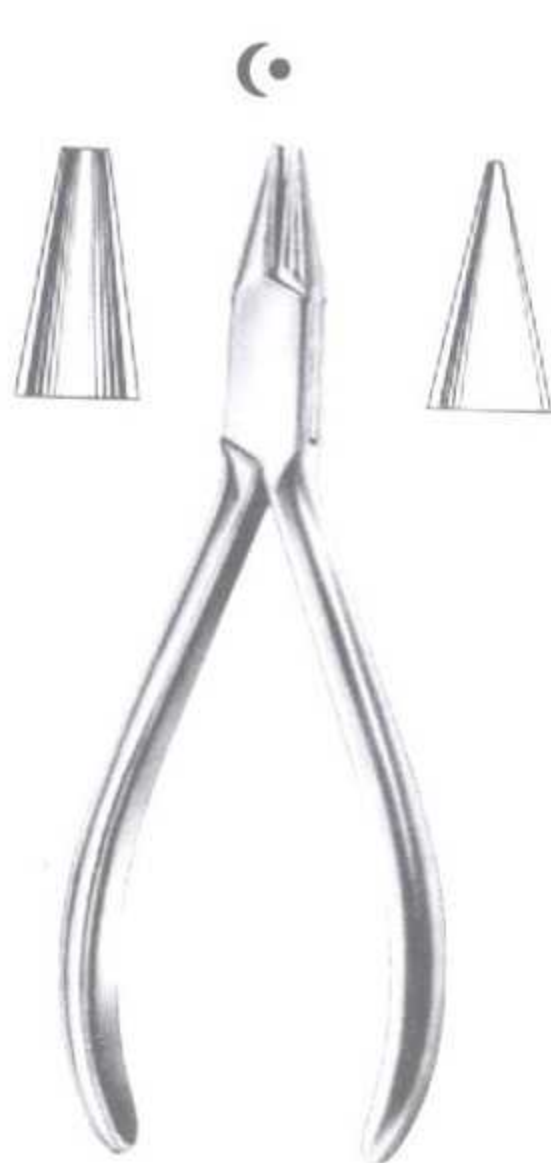

NE-637-02
SCHWARZ
13 cm



NE-637-03
SCHWARZ
14 cm



NE-638-12
12,5 cm



NE-639-12
ANGLE
12,5 cm



NE-640-12
ADAMS
12,5 cm



NE-641-01
ADERER
11,5 cm



NE-641-02
ADERER
13 cm

ORTHODONTIC PLIERS



SKIPLINE

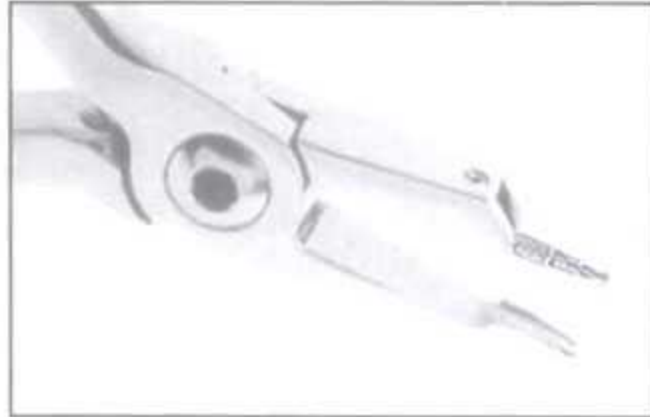

NE-642-01
Omega Loop Forming Plier,
Tweed Style

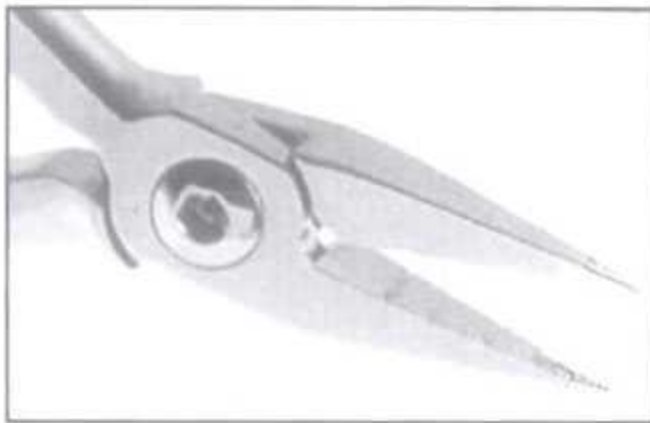

NE-642-04
Jarabak Plier

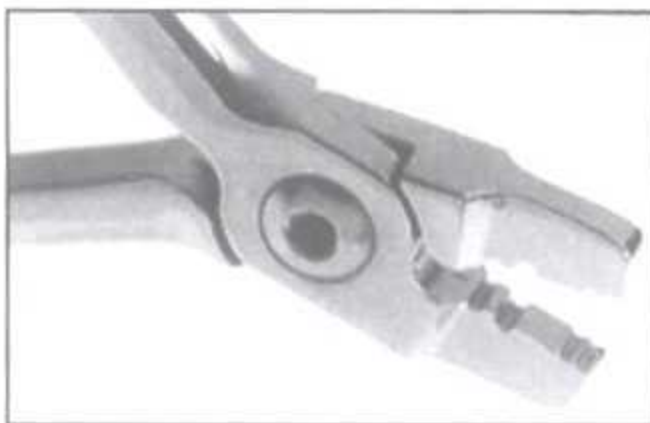

NE-642-07
Lingual Arch Forming Plier



NE-642-10
Rectangular Arch Forming Plier



NE-642-12
Utility Plier (Weingart Style, Slim Tips)

TC

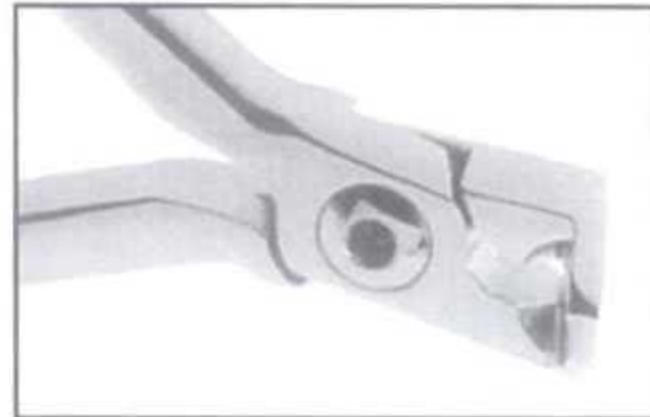

NE-642-02
Distal End Cutter,
Safety Hold

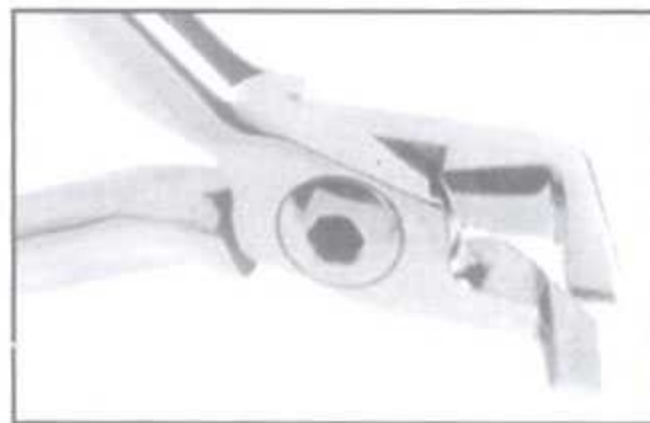

NE-642-05
Small Distal End Cutter,
Safety Hold

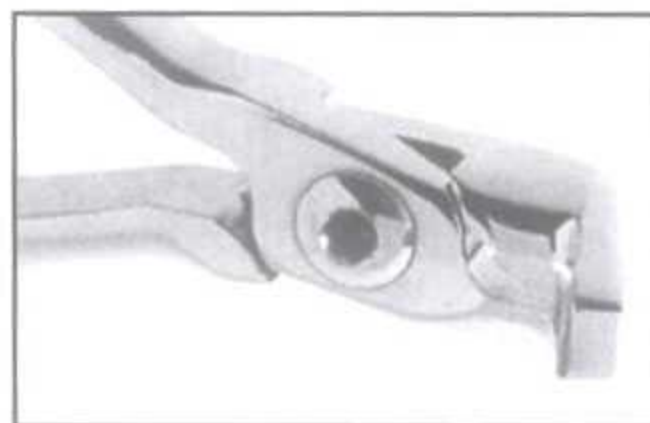

NE-642-08
Long Handled Distal End Cutter

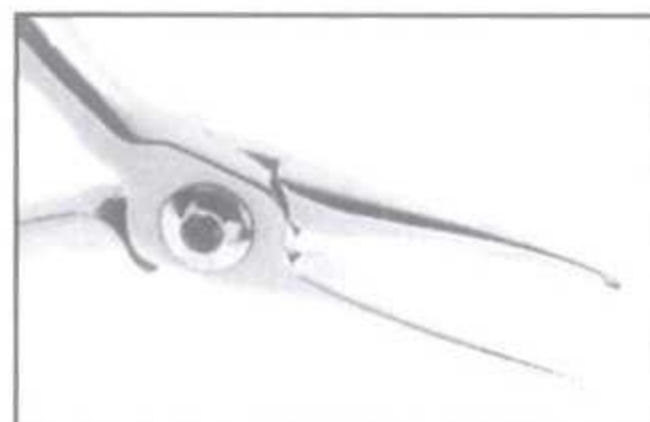

NE-642-11
Straight Utility, How Style



NE-642-13
Offset Utility Plier, How Style

TWEED

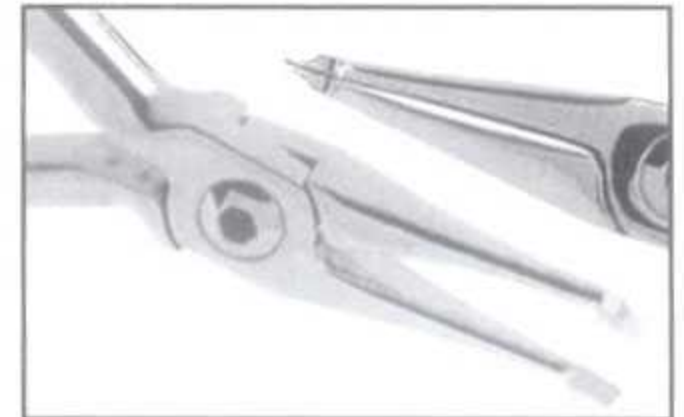

NE-642-03
Band Seating Plier

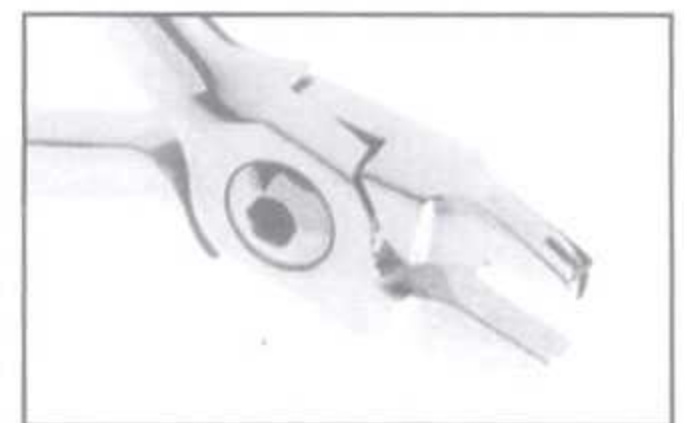

NE-642-06
Ball Hook Crimping Plier

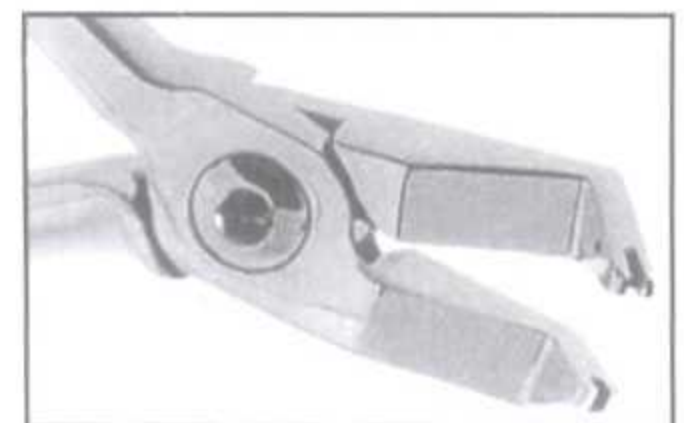

NE-642-09
Angled Ball Hook Crimping Plier

NEW!

TC



IMPRESSION TRAYS



NE-643-01

NE-644-01



NE-645-4DR



NE-646-4SL

		A mm.	B mm.
NE-643-U1	XXS	56	44
NE-643-U2	XS	65	52
NE-643-U3	S	68	54
NE-643-U4	M	71	58
NE-643-U5	L	73	59
NE-643-U6	XL	78	63

		A mm.	B mm.
NE-644-L1	XXS	56	44
NE-644-L2	XS	66	50
NE-644-L3	S	70	52
NE-644-L4	M	73	56
NE-644-L5	L	76	58
NE-644-L6	XL	78	60

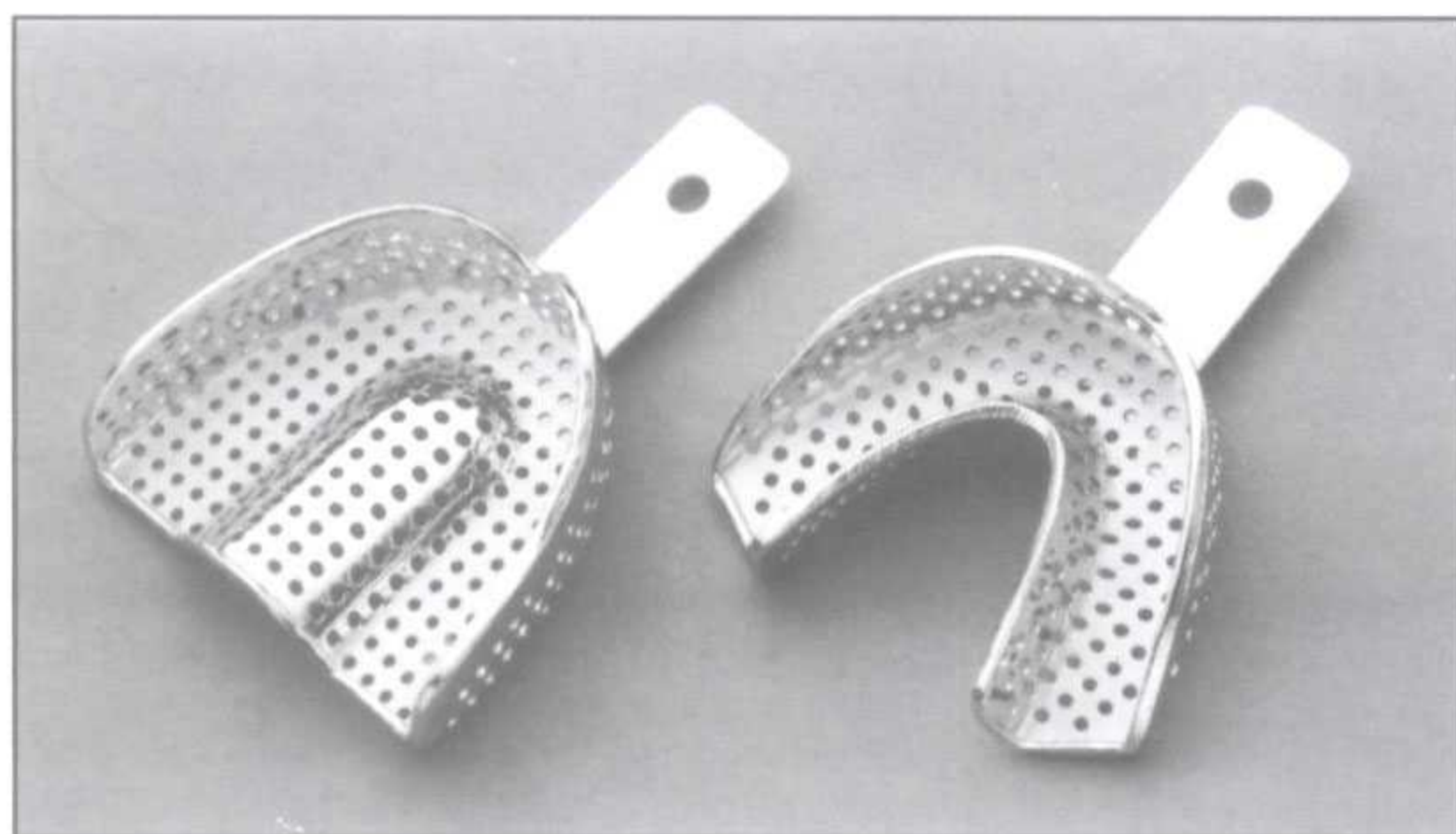

NE-647-01

NE-648-01

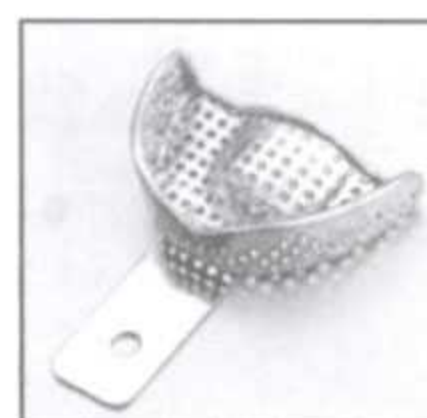

NE-648-03-1UP



NE-648-03-4DR

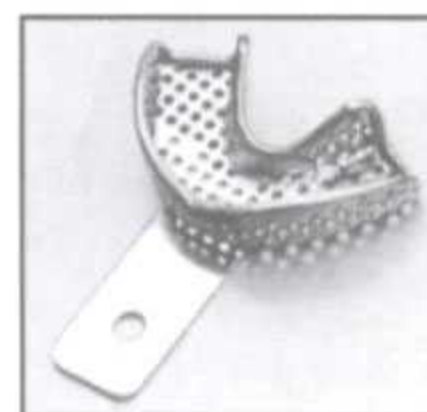

NE-648-04-1LP



NE-648-04-4SL

		A mm.	B mm.
NE-647-U1	XXS	56	44
NE-647-U2	XS	65	52
NE-647-U3	S	68	54
NE-647-U4	M	71	58
NE-647-U5	L	73	59
NE-647-U6	XL	78	63

		A mm.	B mm.
NE-648-L1	XXS	56	44
NE-648-L2	XS	66	50
NE-648-L3	S	70	52
NE-648-L4	M	73	56
NE-648-L5	L	76	58
NE-648-L6	XL	78	60

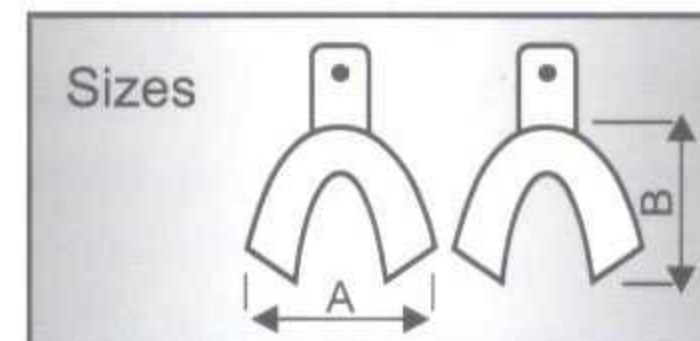
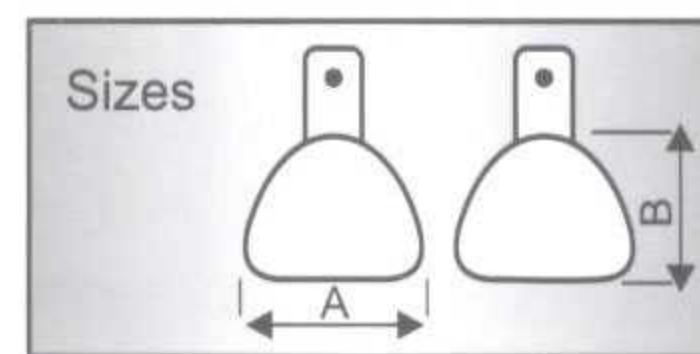

INDEX



A	PAGE	D	PAGE	I	PAGE
ABBOTT	54	DANDY	8	IMPRESSION TRAYS	59
ADAMS	56	DE-BAKEY	16-31	IRIS	1-15-16-32-48
ADERER	56	DEAVER	1	IVORY	47-51-52
ADSON	8-14	DEAN	2		
ADSON TISSUE	31	DENHARD	51		
ALLIS	12	DERF	9		
ALLIS TISSUE	33	DEIFFENBACH-SERREFINE Forceps	15		
ALM	22	DISSECTING & (KIT)	3-25		
AMALGAM CARRIERS	47	DISTAL	47	J	
ANGLE	56	DOUGLASS	16	JACKSON	13-23
AUVARD	23	DOYEN	2-19	JANSEN	24
		DUVAL	31	JONES	10
		DOUBLE-END	47	JOSEPH	13
B		E		K	
BABY-ALLIS	12	EASTMAN	23	KELLY	2-6
BABY-MIXTER	8	ELLIOTT (FILLING INSTRUMENTS)	55	KELLY MOSQUITO	33
BABINSKY	26	ENTEROTOMY	2	KIELLAND	25
BACKHAUS	10-31	ESMARCH	4	KNOWLES BANDAGE	4
BABCOCK	19	EYE PROBE	20	KOGAN	21
BALFOUR	24	EXCAVATORS	55		
BALLENGER / FOESTER	11	EXTRACTING (Forceps)	35 To 41		
BAUMGARTNER	9-30			L	
BEEBEE	32			LARRY	13
BENNETT (FILLING INSTRUMENTS)	55	F		LISTER BANDAGE	4-32
BEER	16	FARABEUF	24	LISTON	5
BERGH	16	FEILCHENFELD	15	LITTAUER	3-16-32
BISHOP-HARMAN	16	FIRST AID	4	LONDON-COLLEGE (PLIER)	49
BLUMENTAL (BONE RONGEUR)	56	FINGER RING CUTTER	5	LORNA	10
BRAUN STADLER	2	FORD (BOWLES)	26	LUCAE	18
BREWER	52	FRAZIER	13	LUCAS	50
BRUNS	4-17			LUER	5
BOUCHERON	17				
BOWMAN	13	G		M	
BOWLES	26	GAUZE SMITH	4	MAGILL	27
BOZEMANN	11	GELPI	24	MARTIN	25
BUCK	26	GILLIES	13	MATHIEU	10
BULE	20	GILLET (EXCAVATOR)	55	MAYO	1
		GRAEFE	16	MAYO DISSECTING	32
		GRAVES (Speculum)	21-34	MAYO HEGAR	9-30
		GRACEY CURETTES	53	MAYO NOBLE	2
		GUENTHER (SCALER)	54	MCHENZIE	12
		GUMCO	22-34	Mc CALL (SCALER)	54
				MERIAM	28
C		H		METZENBAUM	1
CARMALT	15	HARTMAN MASQUITO	6-8	MICHELL	10-54
CHROME	18	HARTMAN ALLIGATOR	17-31	MIRROR HANDLE	17-45
COLLIER	10	HARTMANN (BONE RONGEUR)	56	MIXTER	8
COLLIN	20	HALSEY	9-30	MOGAN	22
COLLIN-DUVAL	31	HALSTEAD MOSQUITO	8-33	MOLT	51
COLLEGE	28	HANK	21	MOSQUITO	6
CROWN	3	HANDLE	17	MOSQUITO WEBSTER	9
CRILE	6	HEGAR	21		
CRILE RANKIN	33	HEISS	22		
CRILE-WOOD	9	HEISTER	51		
CROWN REMOVER	52	HEMINGWAY	50		
CUMINE	54	HENNING	5		
CUTICAL (SCISSOE)	28	HUNTER	15		
		HOFF	10		
		HOLLOW LIGHT	50		



Naqeebe[®]

Enterprises

P.O.Box No.1653,Cheema Streets Noor Pura,
Khadim Ali Road, Sialkot Pakistan.

Tel: +92-52-3522552,3540160

Fax: +92-52-3522455

Mobile: +92-300-6147791

E-mail: ashraf@naqeebe.com

URL: www.naqeebe.com